



Fabricado por:
Backyard Discovery
3305 Airport Drive, Pittsburg, KS 66762
800-856-4445

Basepoint Business Centre: Rivermead Drive, Westlea, Swindon SN5 7EX Teléfono: 0800-118-2476
J.P. Coenstraat 7, The Bridge, The Hague, 2595 WP, Netherlands. Teléfono: 08005678990

PÉRGOLA BEAUMONT 16X12

MODELO N.º 2101562



ADVERTENCIA

Cáncer y daño reproductivo.
www.P65Warnings.ca.gov

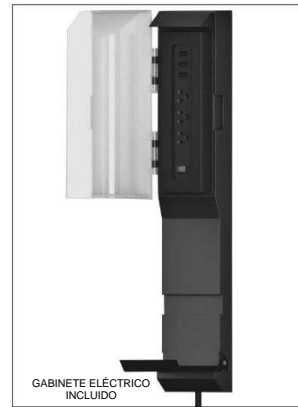
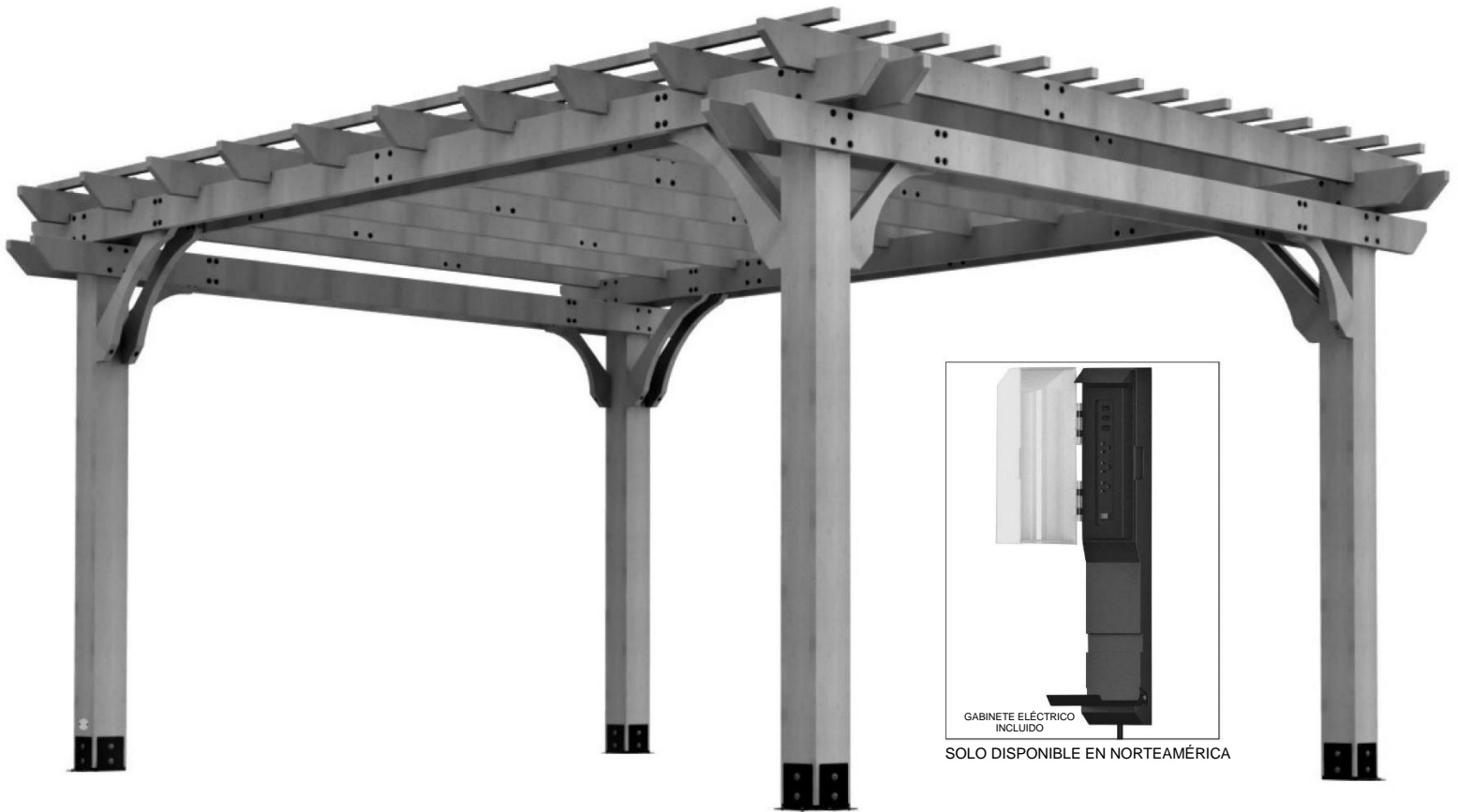

GABINETE ELÉCTRICO INCLUIDO

SOLO DISPONIBLE EN NORTEAMÉRICA

Visite www.backyarddiscovery.com

For the most up to date assembly manual, to register your product, or to order replacement parts

Para obtener instrucciones en español, visite www.backyarddiscovery.com



PASO A PASO FÁCIL
INSTRUCCIONES INTERACTIVAS EN 3D
DESCARGUE LA APLICACIÓN GRATUITA



INSTALACIÓN
SERVICIOS

¡DISPONIBLE!*

Consulte el interior para obtener más detalles

SOLO DISPONIBLE EN LOS ESTADOS UNIDOS

DIMENSIONES BÁSICAS DE INSTALACIÓN Y NOTAS DE MONTAJE

Es de vital importancia que comience con la colocación y nivelación de los cimientos, la losa de hormigón o la plataforma para fijar su estructura.

- Preste mucha atención a los elementos necesarios para cada paso. Asegúrese de estar utilizando las piezas correctas para cada paso.

Utilizar las piezas incorrectas puede provocar un montaje ineficiente.

- Recuerde verificar los servicios subterráneos y los cables eléctricos aéreos.

Se proporcionan soportes de postes con su estructura, lo que le permite instalar permanentemente su estructura en una superficie de madera u hormigón nueva o preexistente. Consulte las Instrucciones de anclaje para obtener más detalles y recomendaciones.

- Se incluyen las piezas necesarias para unir los soportes de poste a la estructura.
- Se incluyen las piezas necesarias para montar la estructura permanentemente en una superficie de hormigón.
- Las piezas necesarias para montar la estructura permanentemente en una plataforma de madera NO están incluidas y deberán comprarse por separado. Debe asegurarse de que haya un amplio soporte estructural debajo de la plataforma antes de realizar la fijación permanente.

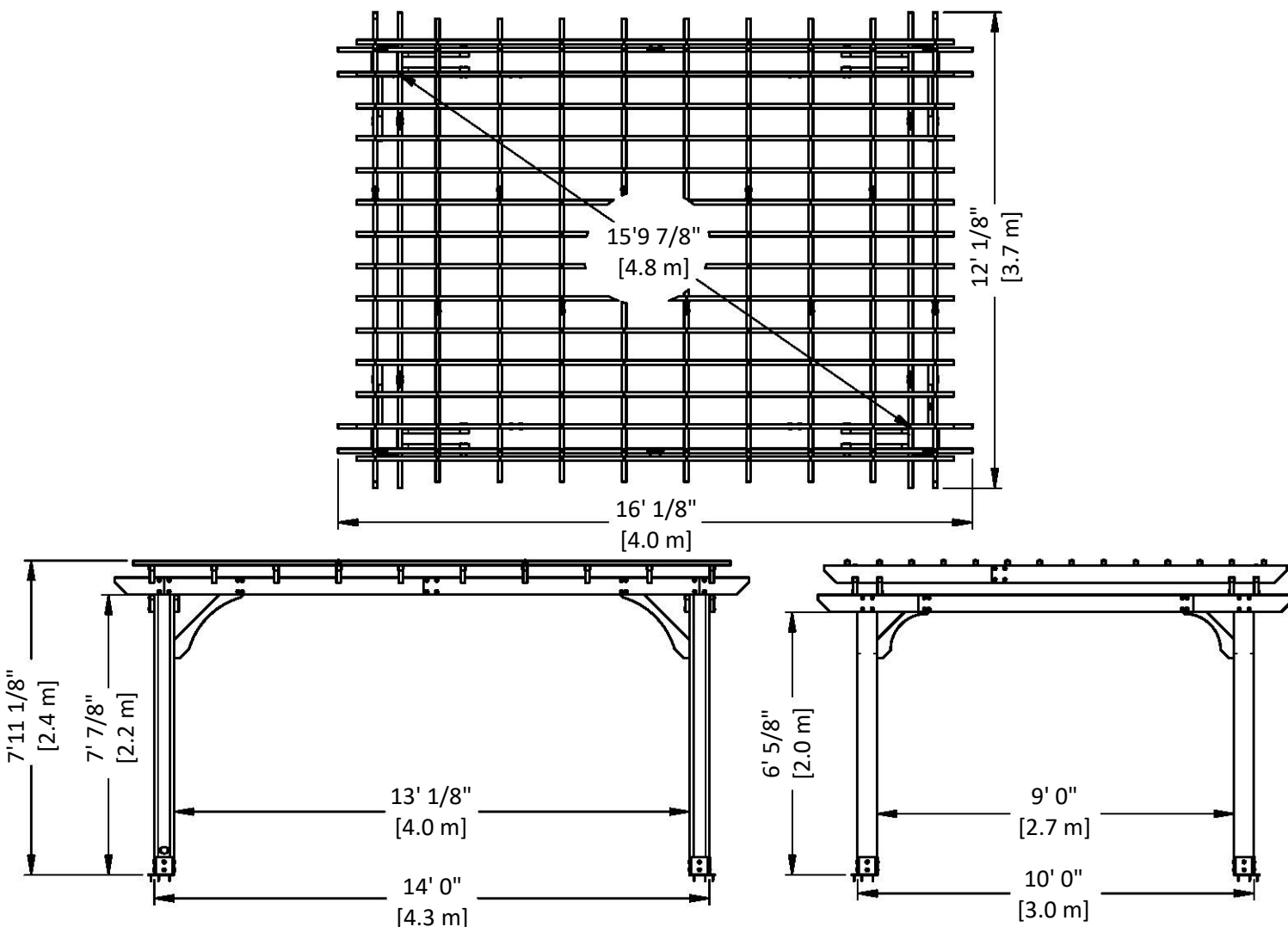

MANUAL DEL PROPIETARIO - DISEÑO DE ANCLAJE

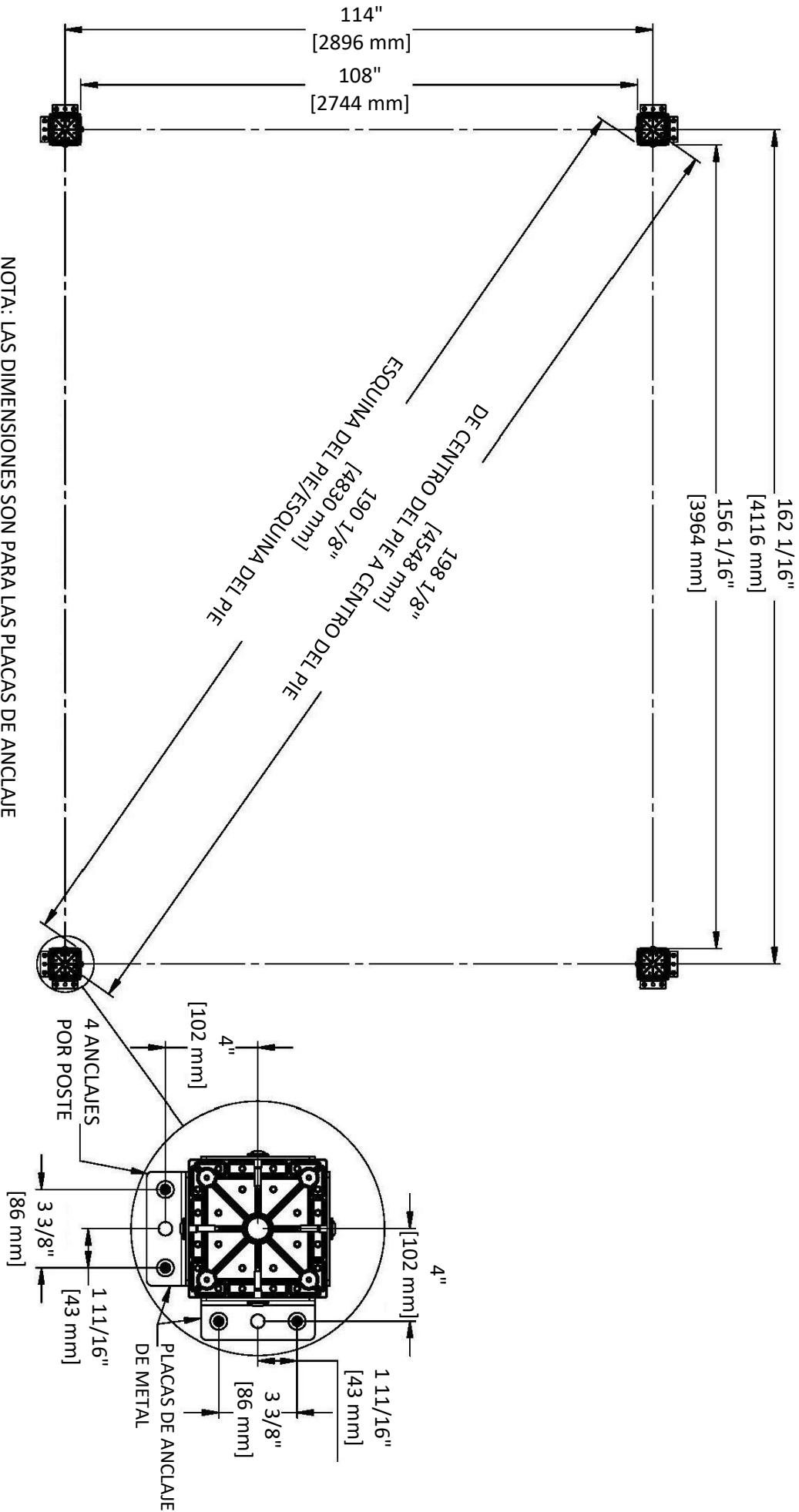

NOTA: LAS DIMENSIONES SON PARA LAS PLACAS DE ANCLAJE SE MONTA A LOS POSTES EXCEPTO DONDE SE INDIQUE

MANUAL DEL PROPIETARIO - IDENTIFICACIÓN DE PIEZAS

Componentes de madera (no a escala)

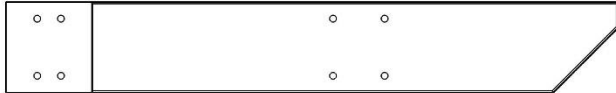

D01 | EXTREMO DE LA VIGUETA - W4L15500
(4) | 1 3/8"x5 1/4"x35 1/2" (36x134x902)

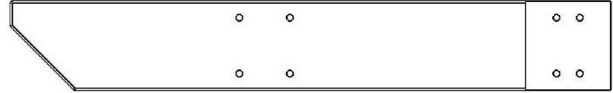

D02 | EXTREMO DE LA VIGUETA - W4L15501
(4) | 1 3/8"x5 1/4"x35 1/2" (36x134x902)



D03 | EXTREMO DE LA VIGUETA - W4L15502
(2) | 1 3/8"x5 1/4"x15" (36x134x382)



D04 | EXTREMO DE LA VIGUETA - W4L15503
(2) | 1 3/8"x5 1/4"x15" (36x134x382)



D05 | EXTREMO DE LA VIGUETA - W4L15504
(2) | 1 3/8"x5 1/4"x56 3/8" (36x134x1431)



D06 | EXTREMO DE LA VIGUETA - W4L15505
(2) | 1 3/8"x5 1/4"x56 3/8" (36x134x1431)



D07 | VIGUETA - W4L15506
(4) | 1 3/8"x5 1/4"x83 1/8" (36x134x2112)



D08 | VIGUETA - W4L15507
(2) | 1 3/8"x5 1/4"x86 1/2" (36x134x2198)

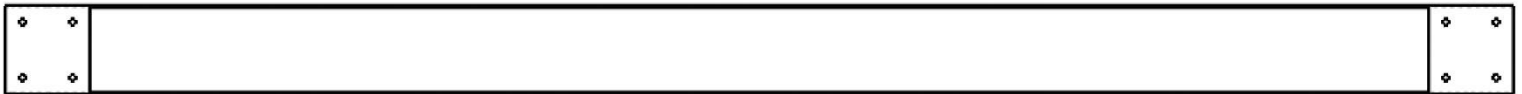

D09 | VIGUETA - W4L15508
(2) | 1 3/8"x5 1/4"x89 1/2" (36x134x2274)

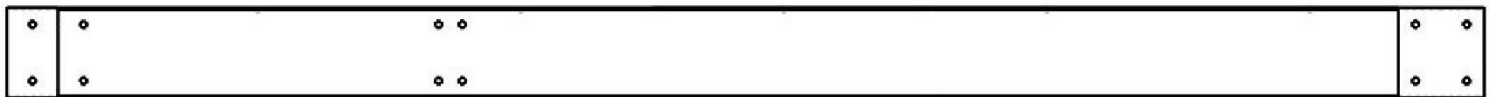

D10 | VIGUETA - W4L15509
(2) | 1 3/8"x5 1/4"x86 1/2" (36x134x2198)

MANUAL DEL PROPIETARIO - IDENTIFICACIÓN DE PIEZAS

Componentes de Madera (no están a escala)

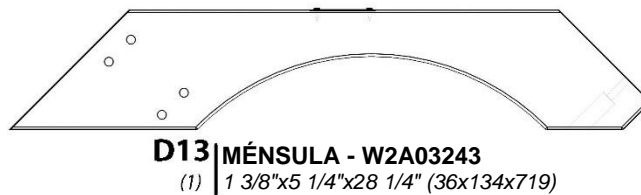
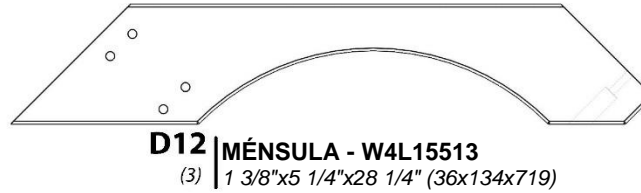
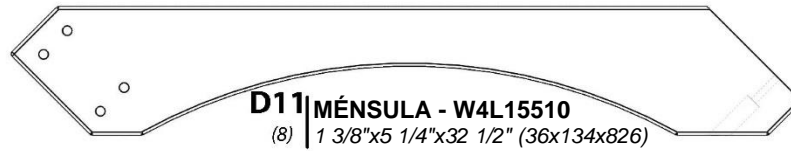

P10 | EXTREMO DE LA CORREA - W4L15511
(28) | 1 3/8"x1 3/8"x62 7/8" (36x36x1598)



P11 | CORREA - W4L15512
(14) | 1 3/8"x1 3/8"x57 7/8" (36x36x1470)

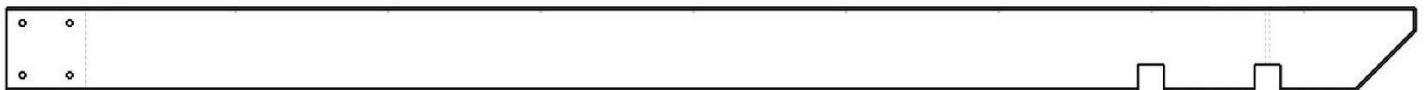

D15 | VIGUETA RANURADA - W4L15517
(10) | 1 3/8"x5 1/4"x89 1/2" (36x134x2274)



P01 | POSTE - W2A03241
(2) | 6"x6"x89 1/2" (152x152x2274)



P02 | POSTE - W2A03242
(2) | 6"x6"x89 1/2" (152x152x2274)

MANUAL DEL PROPIETARIO - IDENTIFICACIÓN DE PIEZAS

Componentes metálicos

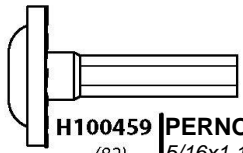

H100459 | PERNO BL NG
(82) | 5/16x1 1/4

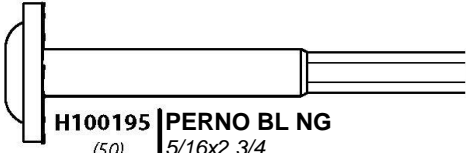

H100195 | PERNO BL NG
(50) | 5/16x2 3/4

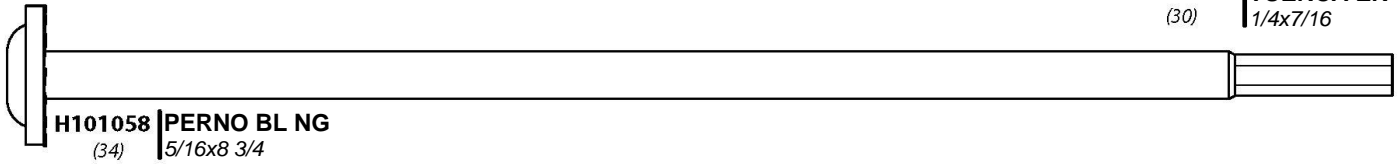

H101058 | PERNO BL NG
(34) | 5/16x8 3/4

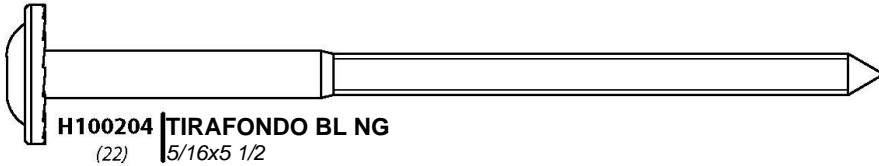

H100204 | TIRAFONDO BL NG
(22) | 5/16x5 1/2

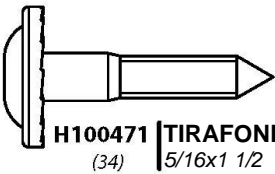

H100471 | TIRAFONDO BL NG
(34) | 5/16x1 1/2

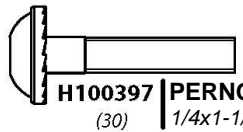

H100397 | PERNO BL NG
(30) | 1/4x1-1/4

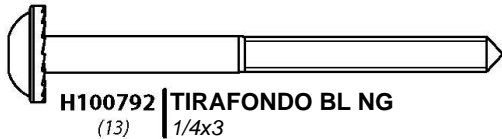

H100792 | TIRAFONDO BL NG
(13) | 1/4x3

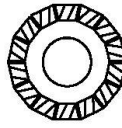

H100198 | ARANDELA DE FIJACIÓN
(185) | EXT NG 8x19

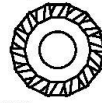

H100405 | ARANDELA DE FIJACIÓN
(43) | EXT NG 6x15

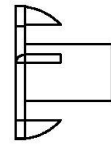

H100379 | TUERCA EN T NG
(163) | 5/16x5/8



H100398 | TUERCA EN T NG
(30) | 1/4x7/16

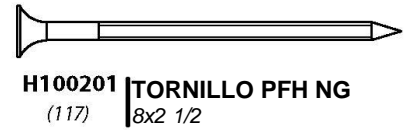

H100201 | TORNILLO PFH NG
(117) | 8x2 1/2

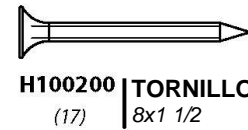

H100200 | TORNILLO PFH NG
(17) | 8x1 1/2

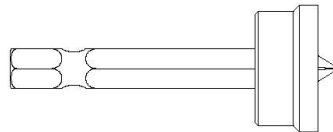

H100764 | TORNILLO AUTORREGULADOR
(1)

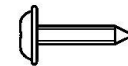

H100202 | TORNILLO PWH NG
(2) | 8x5/8

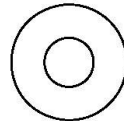

H100630 | ARANDELA PLANA NG
(18) | 8x19



H100120 | TORNILLO DE ANCLAJE DE
HORMIGÓN
(18) | 1/4x2

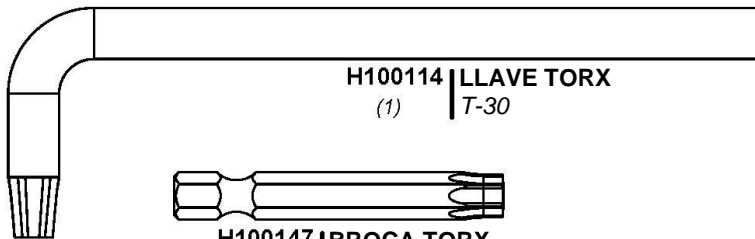

H100114 | LLAVE TORX
(1) | T-30

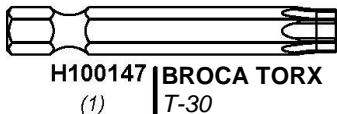

H100147 | BROCA TORX
(1) | T-30

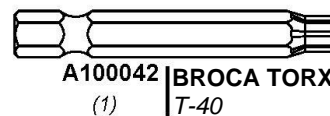

A100042 | BROCA TORX
(1) | T-40



A100041 | LLAVE TORX
(1) | T-40

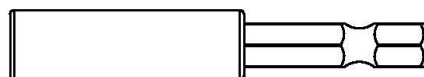

H101100 | DESTORNILLADOR DE
PUNTA MAGNÉTICA
(1)

MANUAL DEL PROPIETARIO - IDENTIFICACIÓN DE PIEZAS

Componentes Accesorios (No a escala)



A100241
(1) | ETIQUETA DE IDENTIFICACIÓN DE BACKYARD (PEQUEÑA) SIN EDADES

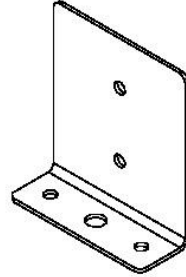

A4M00977
(8) | PLACA DE ANCLAJE DE POSTE

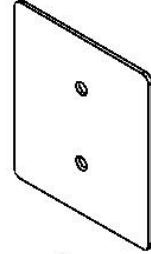

A4M00978
(8) | PLACA DE POSTE

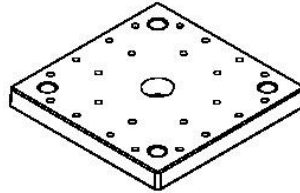

A6P00308
(4) | PIE DE POSTE 6 x 6

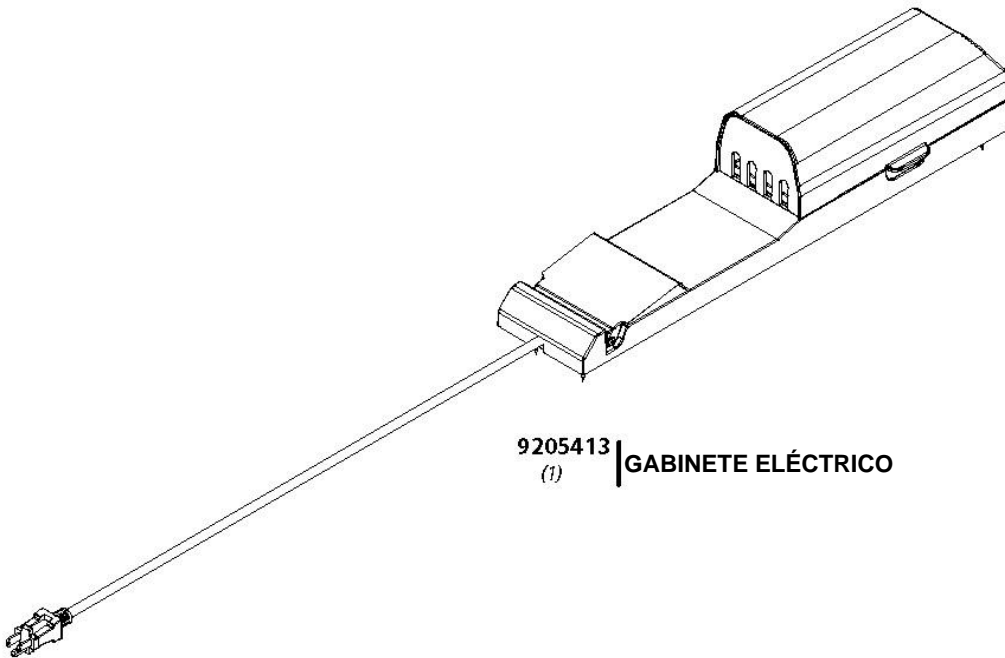

9205413
(1) | GABINETE ELÉCTRICO

ANTES DEL MONTAJE - PASO 1 - CLASIFICACIÓN DE PIEZAS

Para facilitar el montaje, es fundamental que se tome el tiempo de clasificar y organizar las piezas de madera y las piezas metálicas.

PIEZAS DE MADERA:

- Organice las piezas de madera por el número alfanumérico de tres dígitos impreso en cada tabla (ej. P01).
- Si hay varias tablas con el mismo número impreso, separe esas piezas juntas.
- Los números impresos están en la superficie plana o en el extremo de las tablas.
- Deje suficiente espacio: las piezas de madera pueden ocupar mucho espacio.

NOTA: LAS CAJAS NO ESTÁN ORGANIZADAS SEGÚN EL NÚMERO DE TABLA.



PIEZAS METÁLICAS:

- Le recomendamos que separe las piezas metálicas en una mesa separada.
- Las bolsas de piezas metálicas llevan impreso un código de pieza alfanumérico de siete caracteres.
- Puede organizar las piezas metálicas por número de pieza o agruparlas por tipo de pieza (pernos, tuercas, etc.).
- Durante el montaje, solo necesita consultar los últimos cuatro caracteres del número.

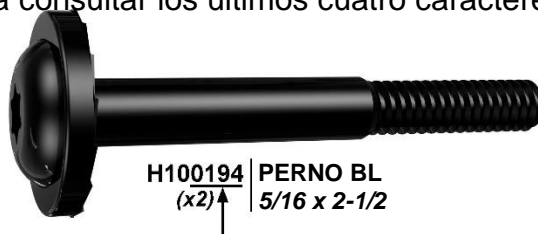

H100194 | PERNO BL
(x2) ↑ 5/16 x 2-1/2

ANTES DEL MONTAJE - PASO 2 - HERRAMIENTAS REQUERIDAS



Taladro inalámbrico
o eléctrico



Accesorios de
perforación:
Cabezal Phillips



Brocas de 1/8", 3/16",
3/8" y 7/16"



Destornillador Phillips



Llaves de extremos abiertos de
1/2" y 9/16"



Trinquete con adaptadores de
3/8", llave de tubo STD de 1/2" y
7/16" y llave de tubo de cuello
largo de 1/2" y 7/16"



Martillo de orejas

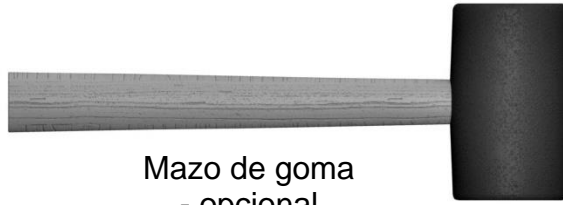

Mazo de goma
- opcional

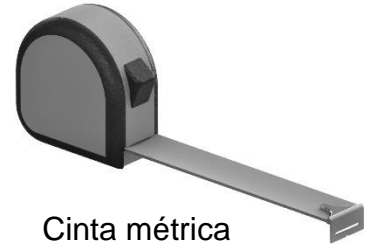

Cinta métrica

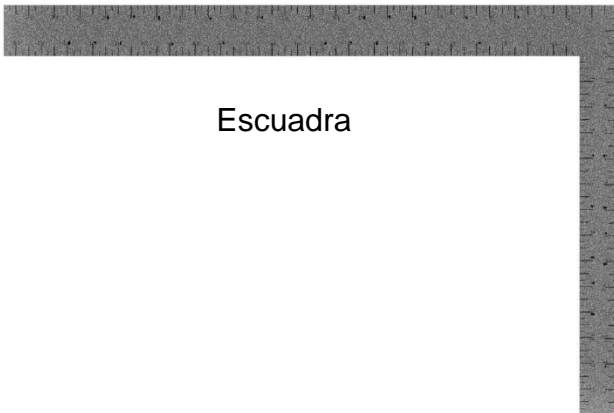

Escuadra

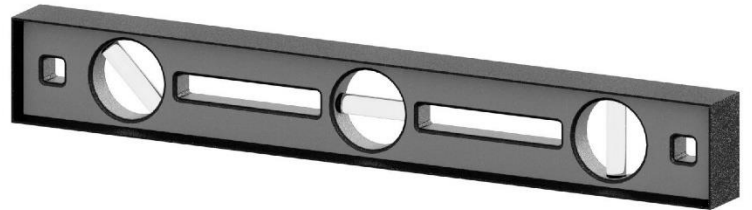

Nivel 24"

ANTES DEL MONTAJE - PASO 3 - ELIJA EL MÉTODO DE MONTAJE

Hay varios tipos de instrucciones de montaje disponibles.

- Manual de montaje impreso incluido con el juego.
- APLICACIÓN BILT: instrucciones interactivas en 3D
- Combinación del manual impreso y la APLICACIÓN BILT (Nota: Los números de paso pueden diferir entre los dos métodos)



BILT.®

Escanee para obtener instrucciones sencillas en 3D

Descargue la aplicación BILT antes de comenzar

Download on the App Store

GET IT ON Google Play

Hardware Needed

17

< || >

PASO 4 - MONTAJE DE LA PÉRGOLA

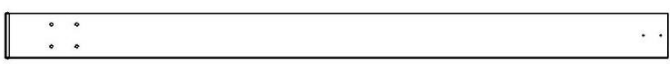

P01 | POSTE - W2A03241
(2) 6"x6"x89 1/2" (152x152x2274)

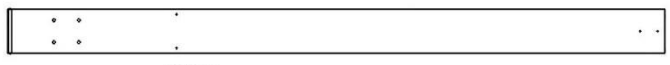

P02 | POSTE - W2A03242
(2) 6"x6"x89 1/2" (152x152x2274)

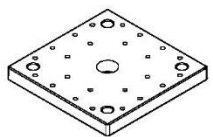

A6P00308 | PIE DE POSTE 6 x 6
(4)



H100200 | TORNILLO PFH NG
(16) 8x1 1/2

COMPLETE ESTE PASO DOS VECES.

PARA FACILIDAD DE MONTAJE, RECOMENDAMOS USO DE CABALLOS DE SIERRA PARA LOS PASOS 4 AL 10.

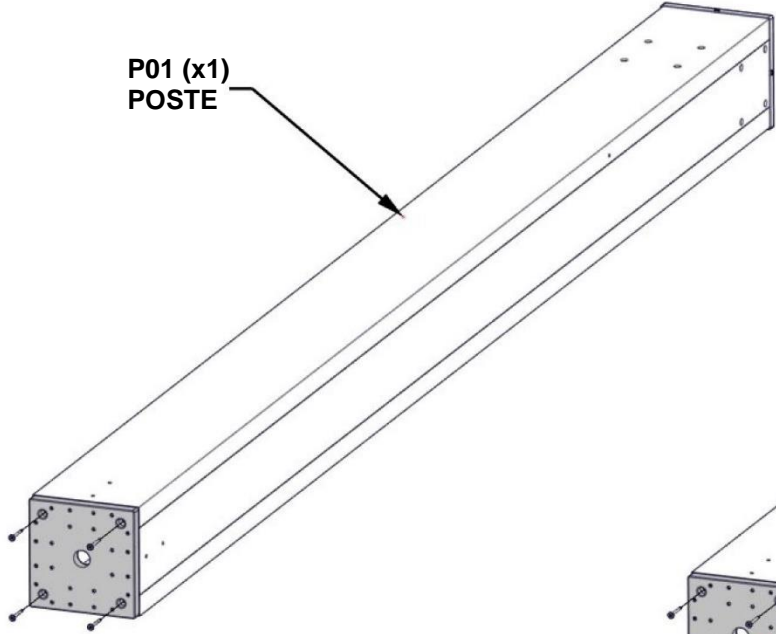

P01 (x1)
POSTE

ALINEE EL PIE DEL POSTE Y TALADRE AGUJEROS PILOTO DE 1/8" PARA LOS HERRAJES.

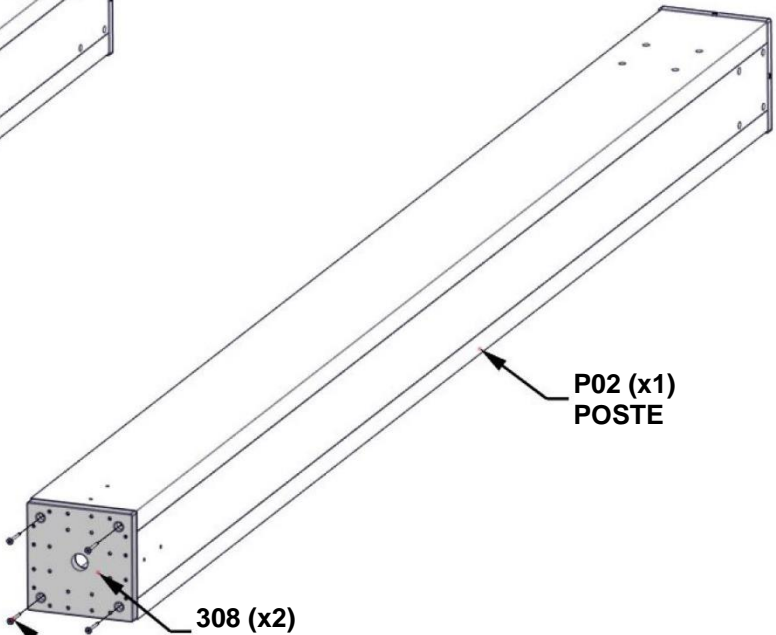

P02 (x1)
POSTE

308 (x2)
PIE DE POSTE 6 x 6

200 (x8)
TORNILLO 6x6 - 1 1/2"

PASO 5 - MONTAJE DE LA PÉRGOLA

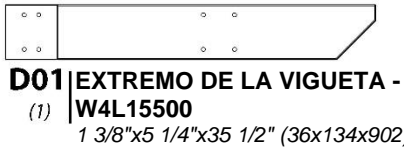

D01 | EXTREMO DE LA VIGUETA - W4L15500
(1) | 1 3/8"x5 1/4"x35 1/2" (36x134x902)



D02 | EXTREMO DE LA VIGUETA - W4L15501
(1) | 1 3/8"x5 1/4"x35 1/2" (36x134x902)



D07 | VIGUETA - W4L15506
(1) | 1 3/8"x5 1/4"x83 1/8" (36x134x2112)



D12 | MÉNSULA - W4L15513
(1) | 1 3/8"x5 1/4"x28 1/4" (36x134x719)



D13 | MÉNSULA - W2A03243
(1) | 1 3/8"x5 1/4"x28 1/4" (36x134x719)

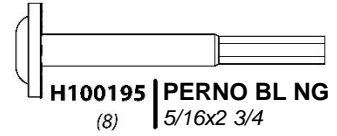

H100195 | PERNO BL NG
(8) | 5/16x2 3/4

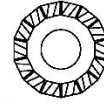

H100198 | ARANDELA DE FIJACIÓN EXT NG 8x19
(8)

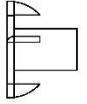

H100379 | TUERCA EN T NG 5/16x5/8
(8)

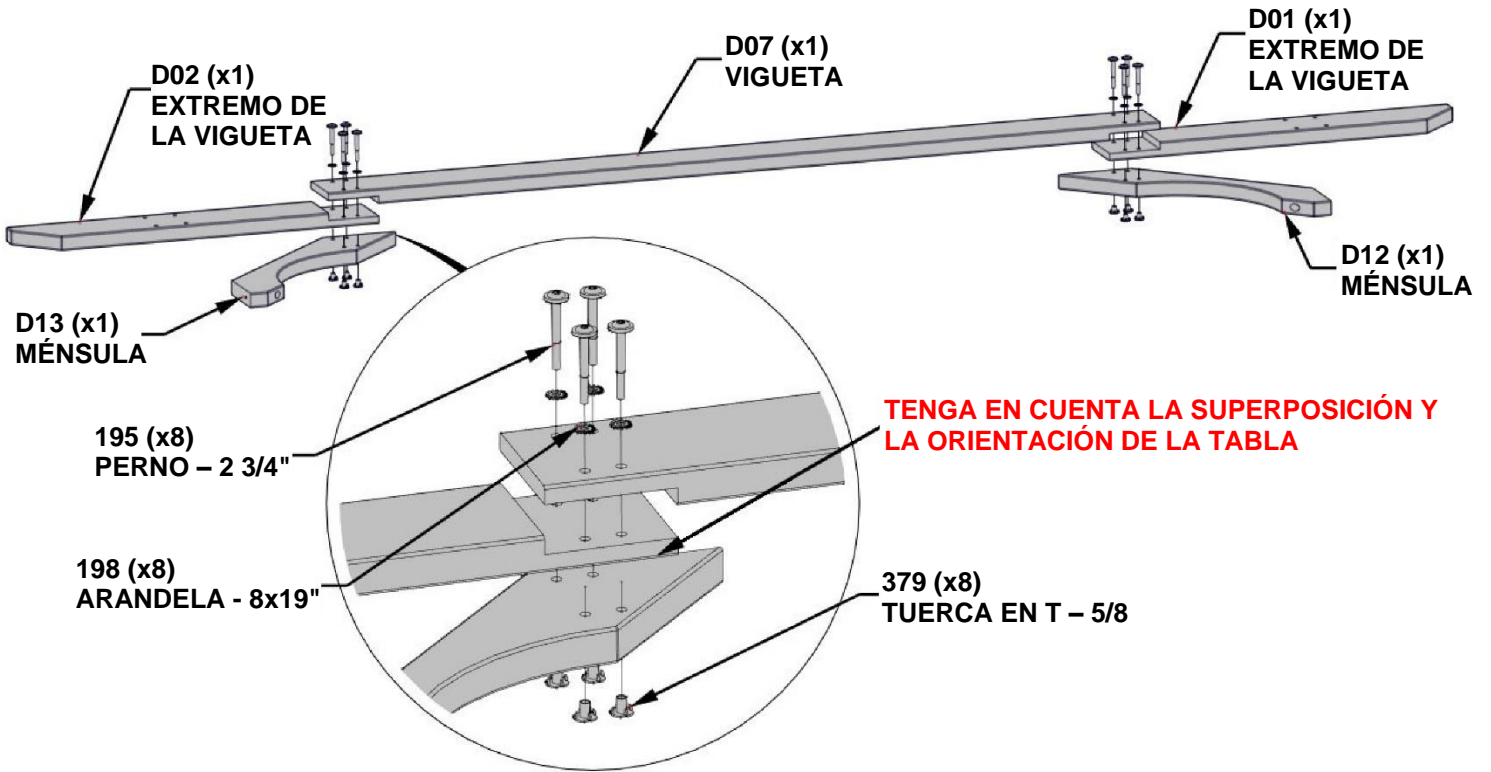

PASO 6 - MONTAJE DE LA PÉRGOLA



D01 EXTREMO DE LA VIGUETA - W4L15500
(1) 1 3/8"x5 1/4"x35 1/2" (36x134x902)

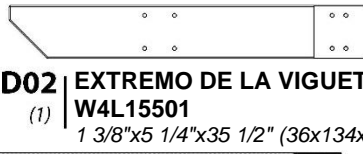

D02 EXTREMO DE LA VIGUETA - W4L15501
(1) 1 3/8"x5 1/4"x35 1/2" (36x134x902)



D07 VIGUETA - W4L15506
(1) 1 3/8"x5 1/4"x83 1/8" (36x134x2112)



D12 MÉNSULA - W4L15513
(2) 1 3/8"x5 1/4"x28 1/4" (36x134x719)

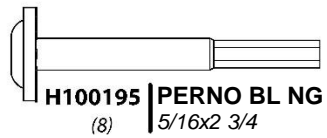

H100195 PERNO BL NG
(8) 5/16x2 3/4

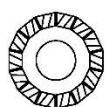

H100198 ARANDELA DE FIJACIÓN
(8) EXT NG 8x19

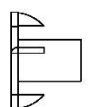

H100379 TUERCA EN T NG
(8) 5/16x5/8

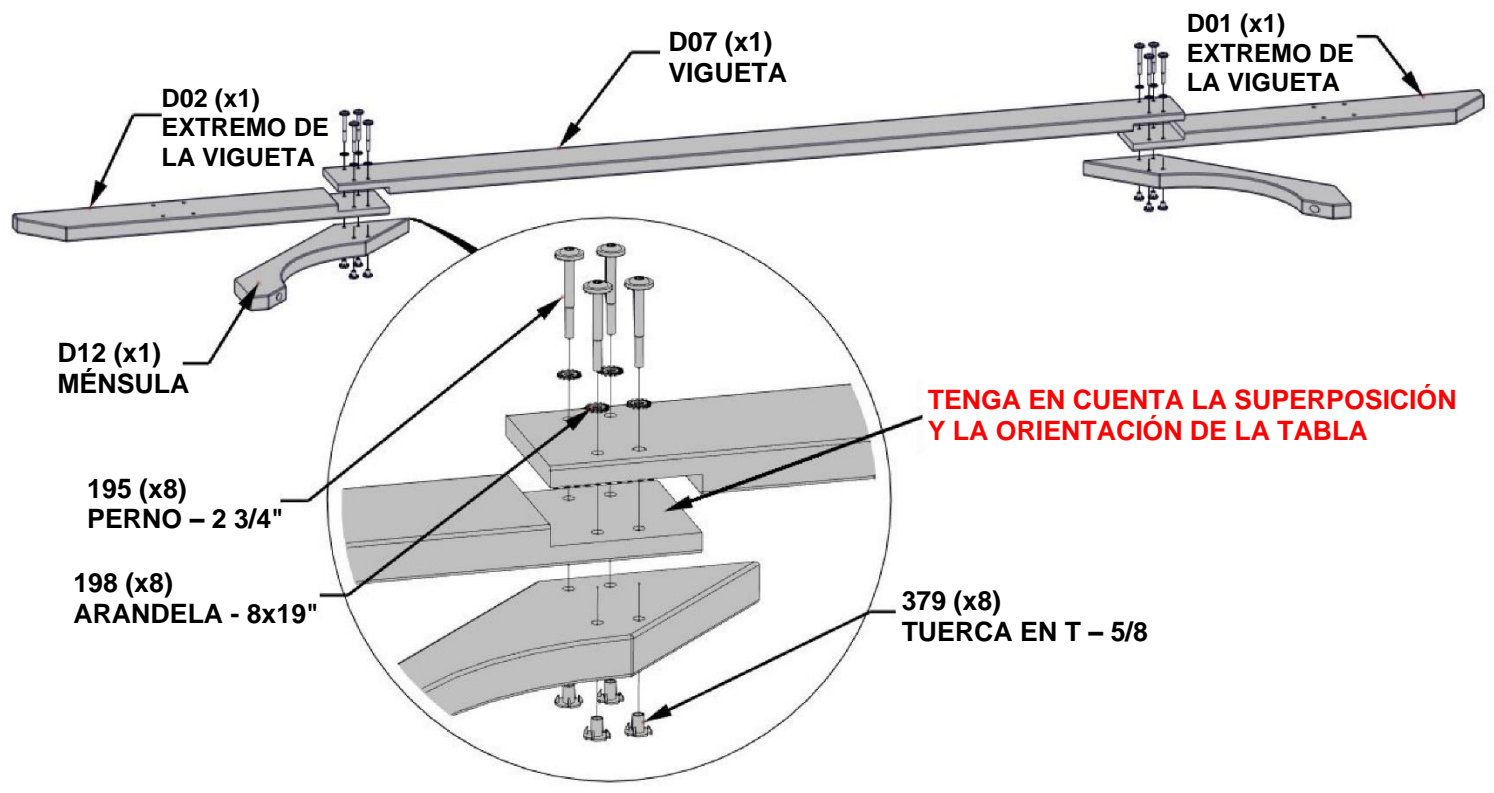

PASO 7 - MONTAJE DE LA PÉRGOLA

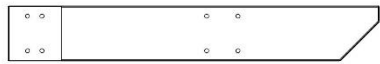

D01 EXTREMO DE LA VIGUETA -
W4L15500
(2) 1 3/8"x5 1/4"x35 1/2" (36x134x902)

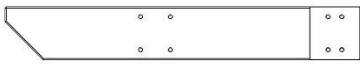

D02 EXTREMO DE LA VIGUETA -
W4L15501
(2) 1 3/8"x5 1/4"x35 1/2" (36x134x902)

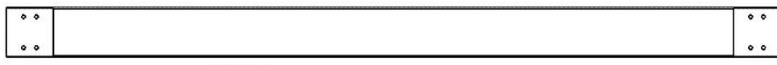

D07 VIGUETA - W4L15506
(2) 1 3/8"x5 1/4"x83 1/8" (36x134x2112)

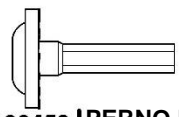

H100459 PERNO BL NG
(16) 5/16x2 3/4

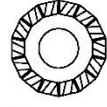

H100198 ARANDELA DE
FIJACIÓN
EXT NG 8x19
(16)

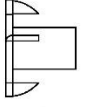

H100379 TUERCA EN
T NG
(16) 5/16x5/8

COMPLETE ESTE PASO DOS VECES.

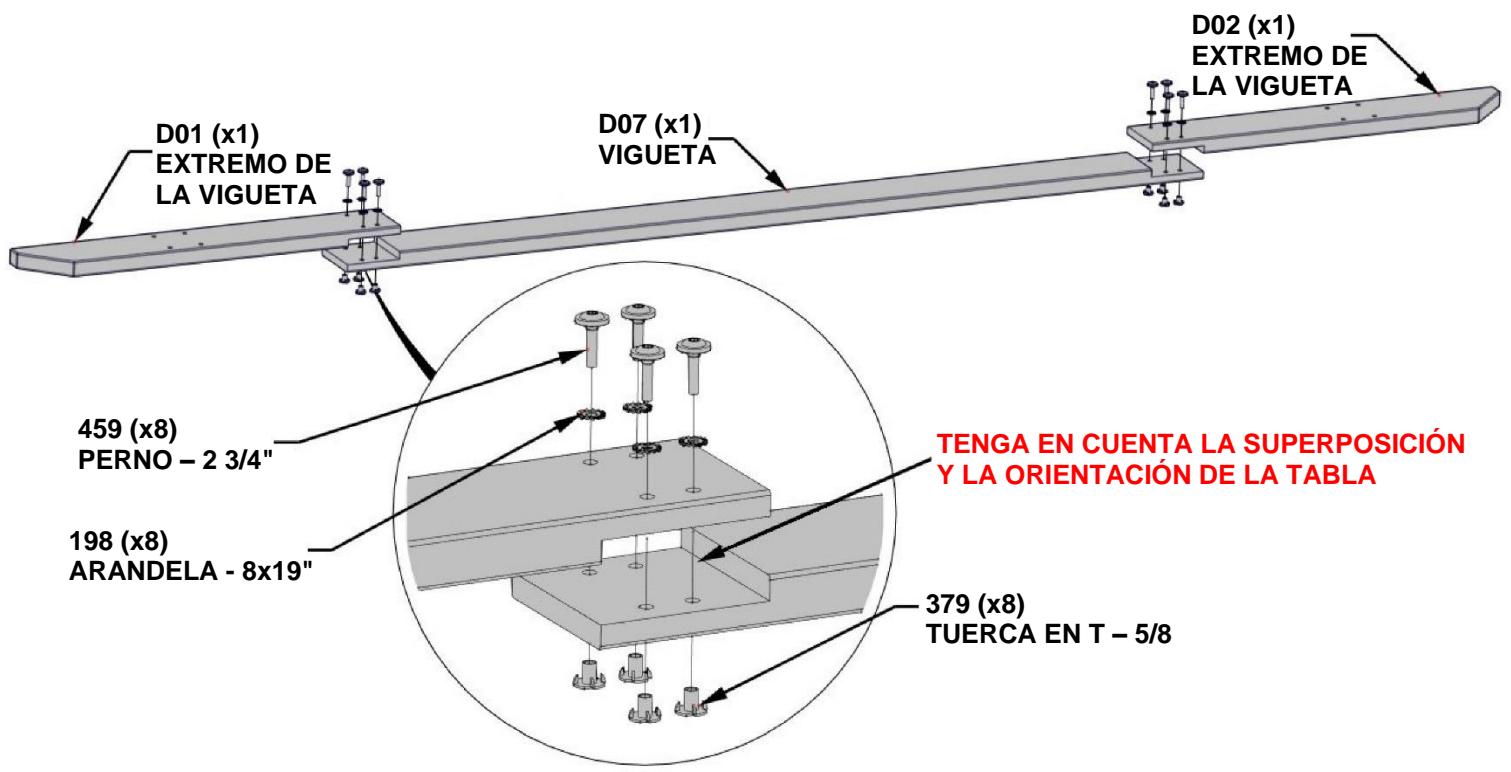

PASO 8 - MONTAJE DE LA PÉRGOLA

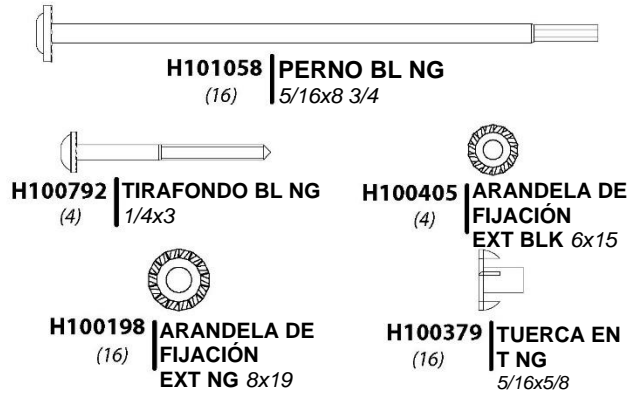
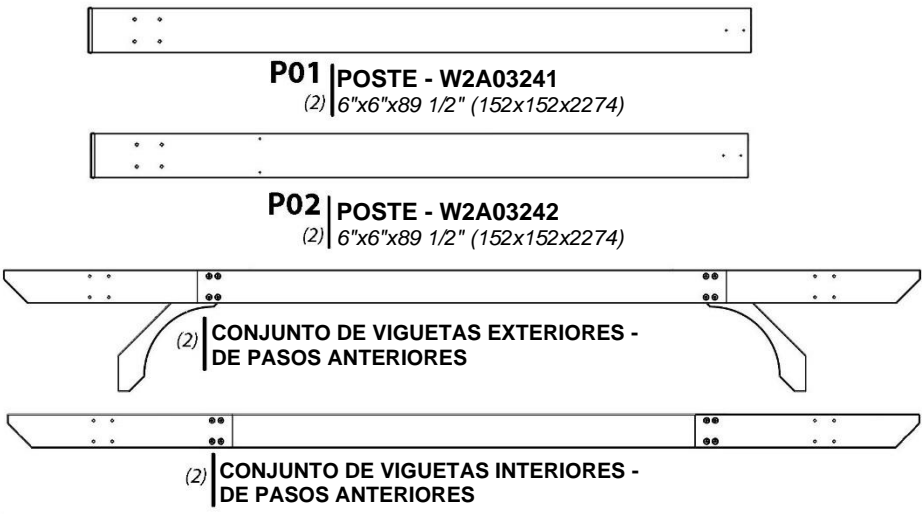

MONTE COMO SE MUESTRA UTILIZANDO LOS ORIFICIOS GUÍA PREVIAMENTE PERFORADOS EN LOS POSTES.

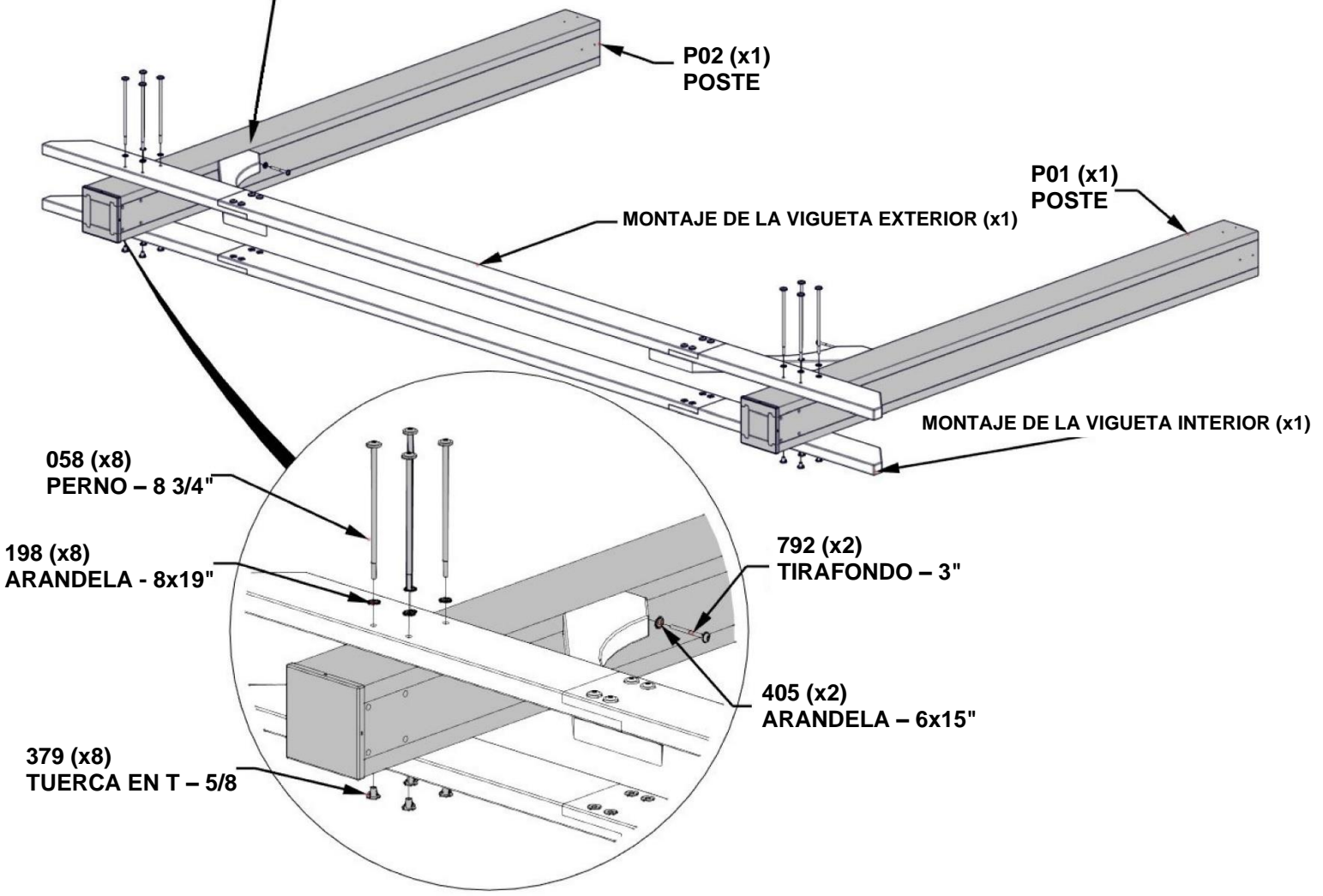

PASO 9 - MONTAJE DE LA PÉRGOLA

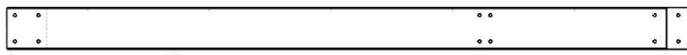

D08 | VIGUETA - W4L15507
(2) | 1 3/8"x5 1/4"x86 1/2" (36x134x2198)

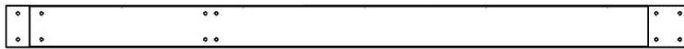

D10 | VIGUETA - W4L15509
(2) | 1 3/8"x5 1/4"x86 1/2" (36x134x2198)



D11 | MÉNSULA - W4L15510
(4) | 1 3/8"x5 1/4"x32 1/2" (36x134x826)

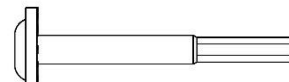

H100195 | PERNO BL NG
(16) | 5/16x2 3/4

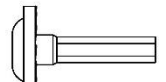

H100459 | PERNO BL NG
(8) | 5/16x1 1/4



H100198 | ARANDELA DE FIJACIÓN EXT NG 8x19
(24)



H100379 | TUERCA EN T NG
(24) | 5/16x5/8

COMPLETE ESTE PASO DOS VECES.

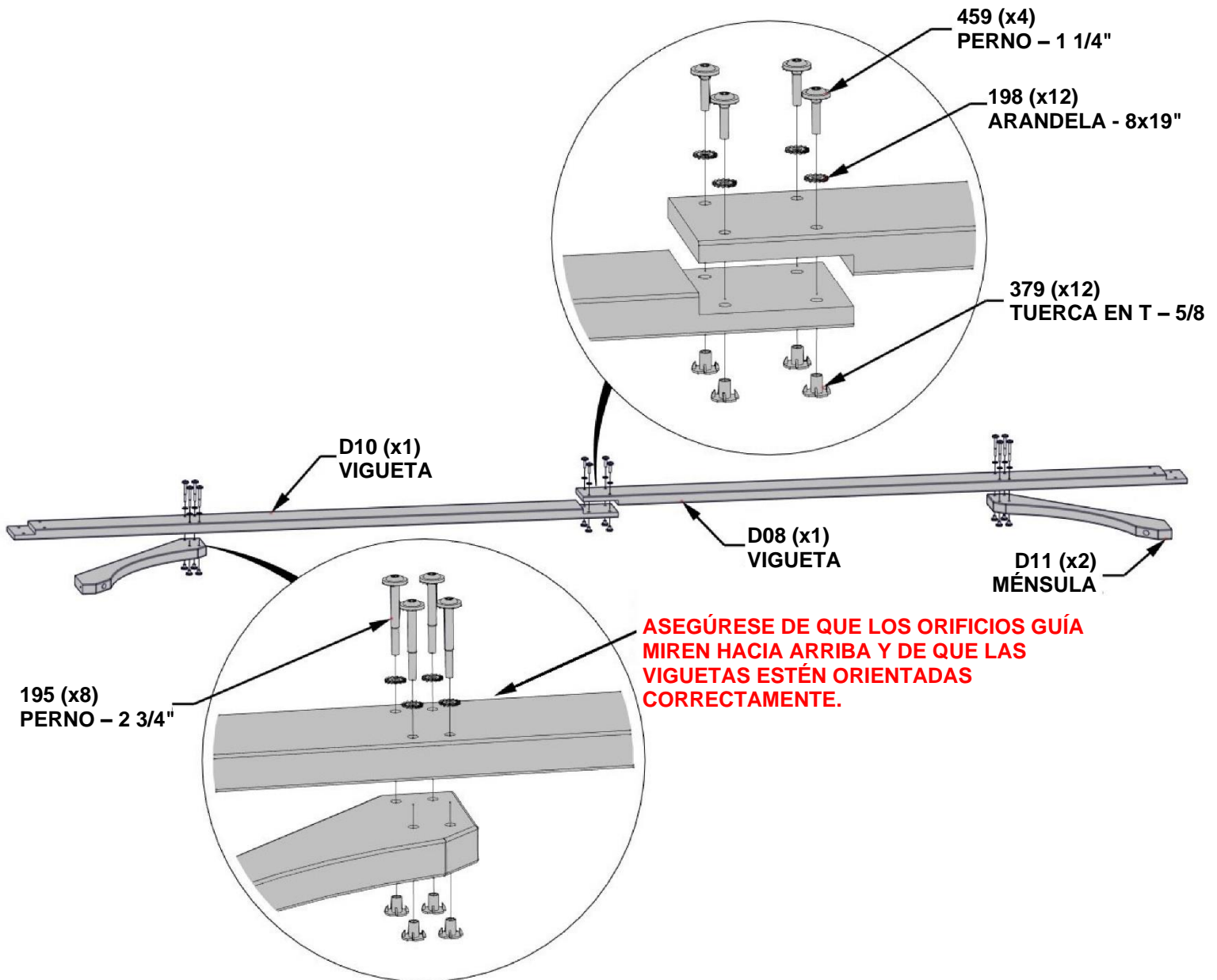

PASO 10 - MONTAJE DE LA PÉRGOLA

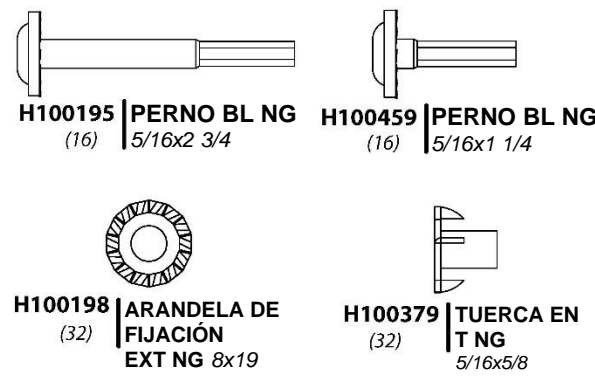
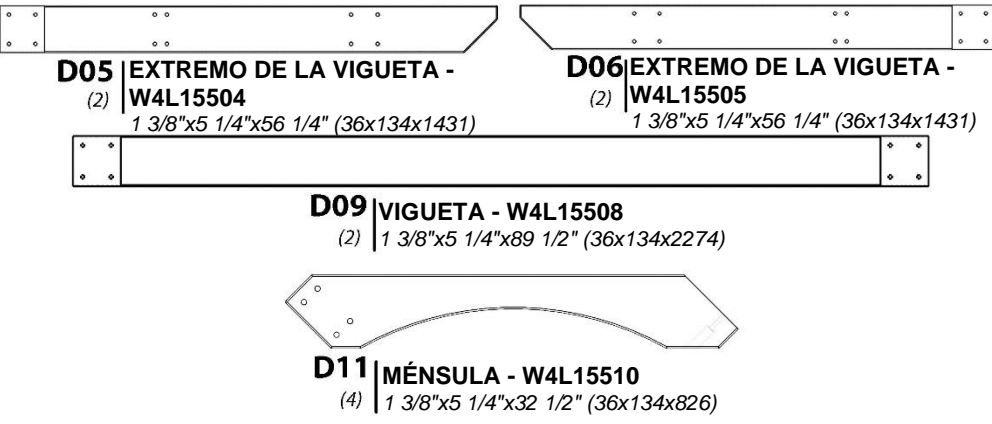

COMPLETE ESTE PASO DOS VECES.

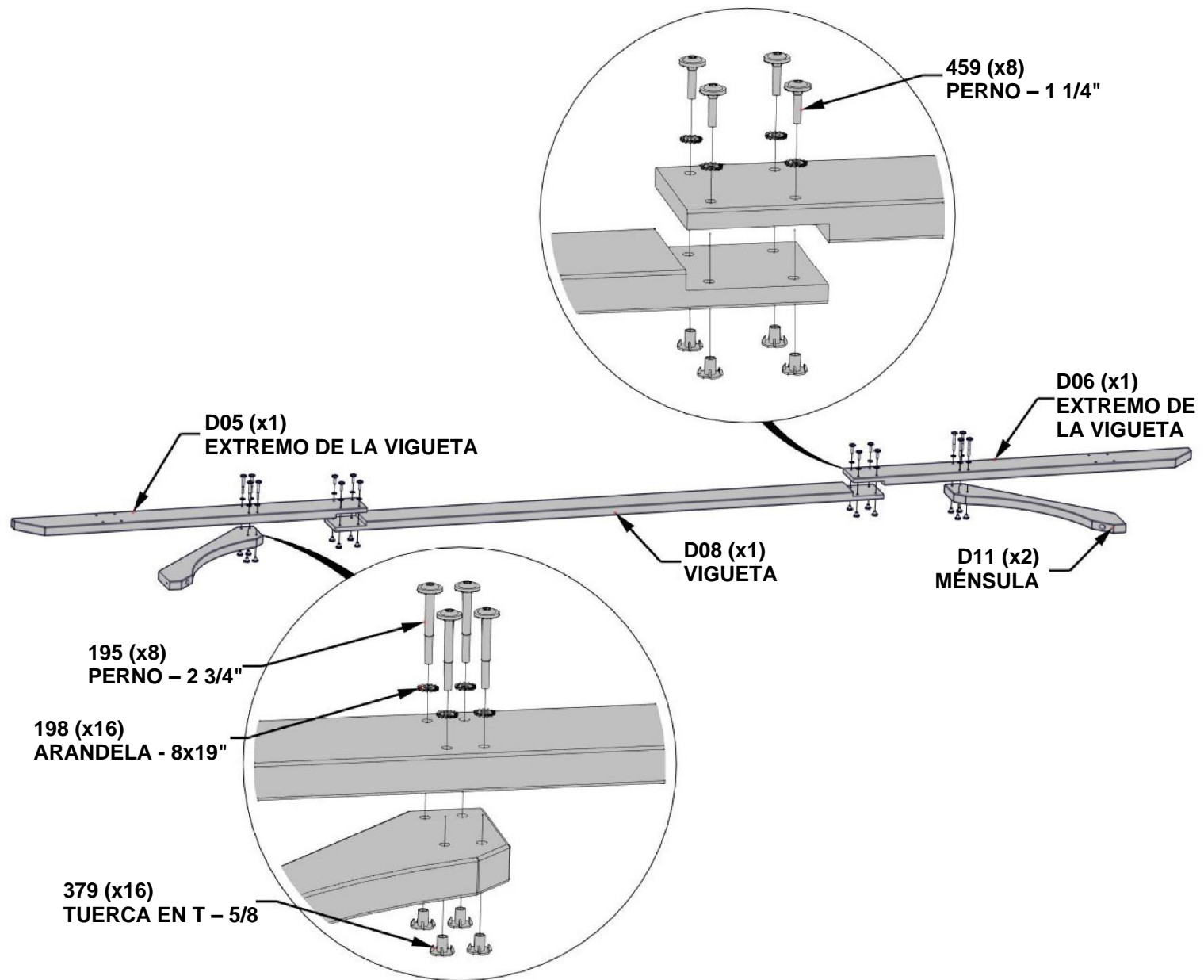

PASO 11 - MONTAJE DE LA PÉRGOLA

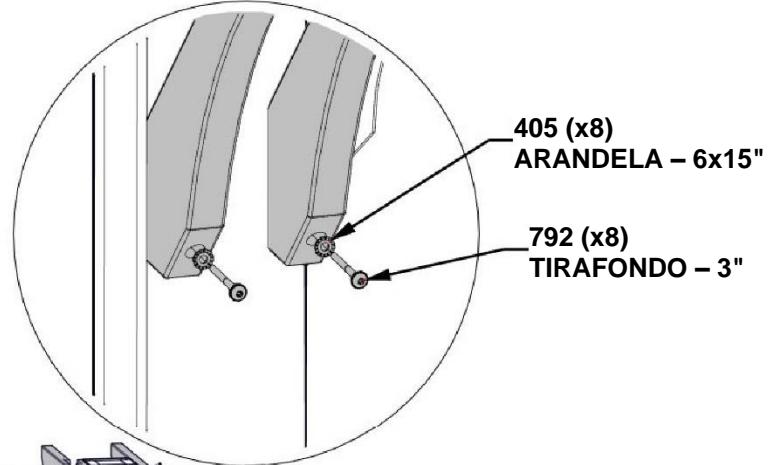
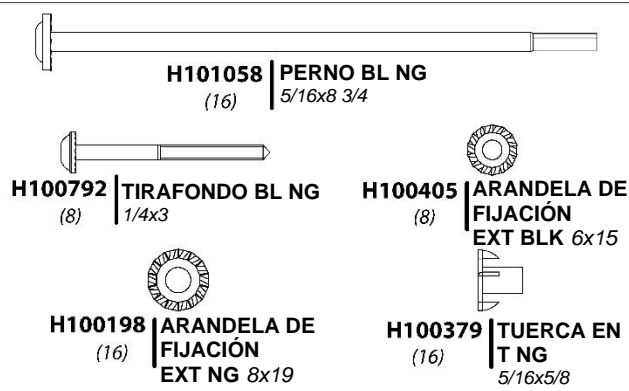
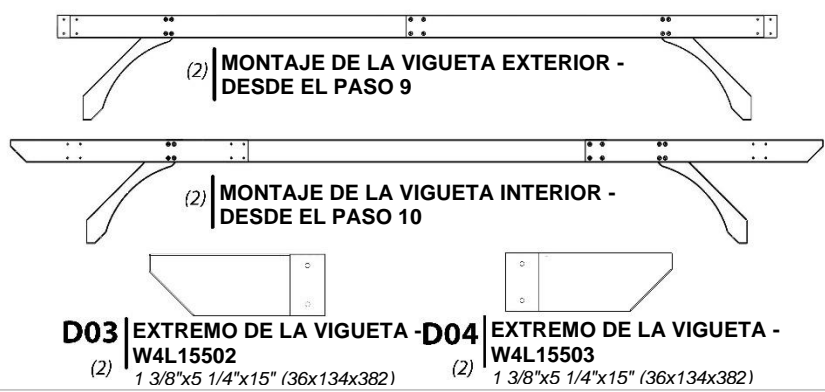

CON AMBOS MONTAJES DEL MONTANTE DE PIE, ATORNILLE EL MONTAJE DE LA VIGUETA INTERIOR Y EXTERIOR A UNO DE LOS LADOS. LUEGO ATORNILLE EL MONTAJE DE LA VIGUETA AL OTRO LADO.

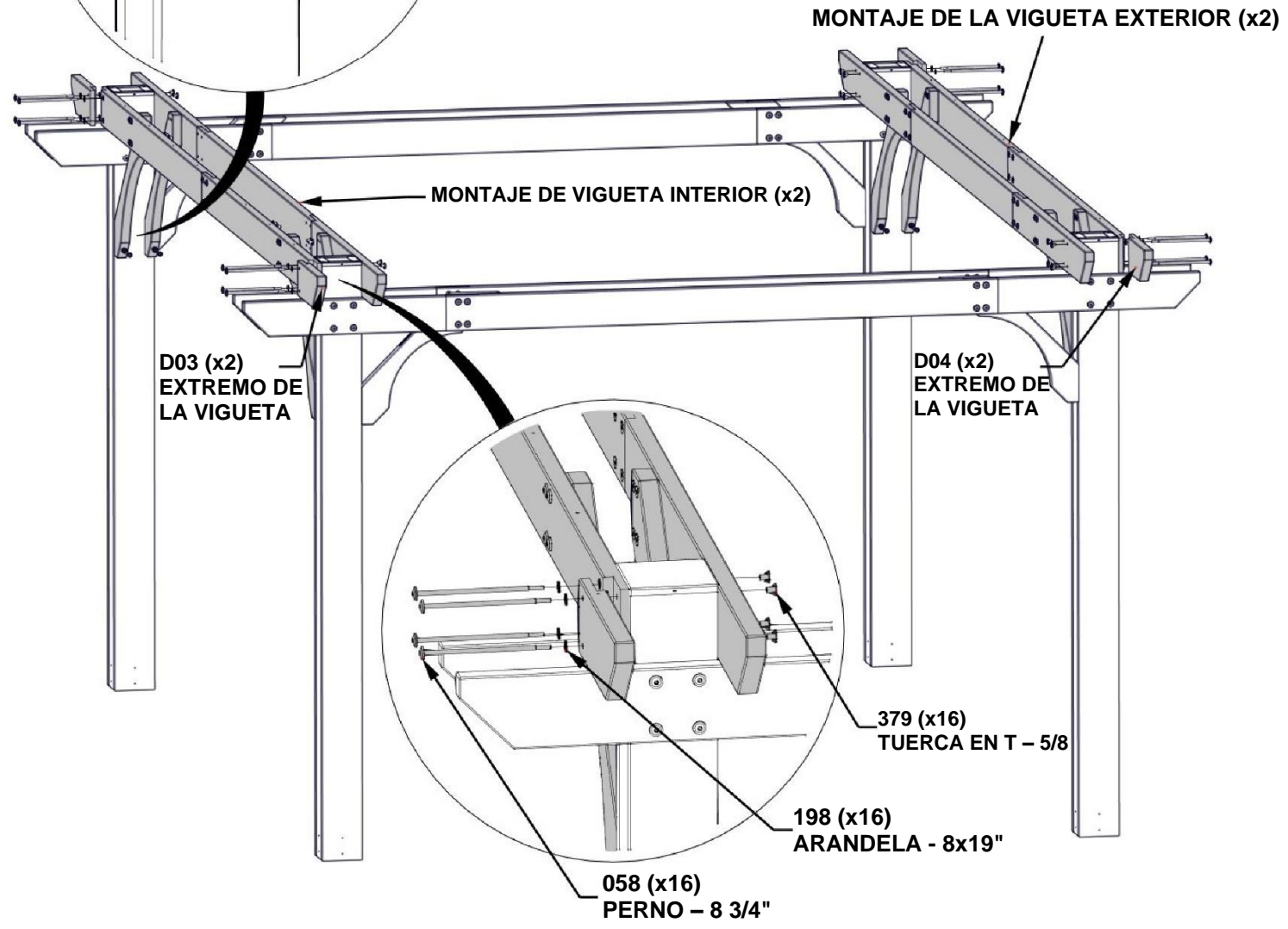

NIVELÉ TODOS LOS POSTES CON LAS VIGUETAS Y AJUSTE COMPLETAMENTE TODOS LOS PERNOS Y TORNILLOS.

NOTA: UNA TERCERA PERSONA PUEDE AYUDARLO EN ESTE PASO.

PASO 12 - MONTAJE DE LA PÉRGOLA



D14 VIGUETA RANURADA - W4L15515
(10) 1 3/8"x5 1/4"x55 3/4" (36x134x1416)

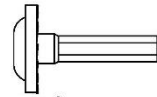

H100459 PERNO BL NG
(40) 5/16x1 1/4

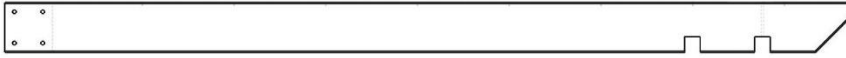

D15 VIGUETA RANURADA - W4L15517
(10) 1 3/8"x5 1/4"x89 1/2" (36x134x2274)



H100198 ARANDELA DE
(40) FIJACIÓN
EXT NG 8x19



H100379 TUERCA EN
(40) T NG
5/16x5/8

COMPLETE ESTE PASO OCHO VECES.

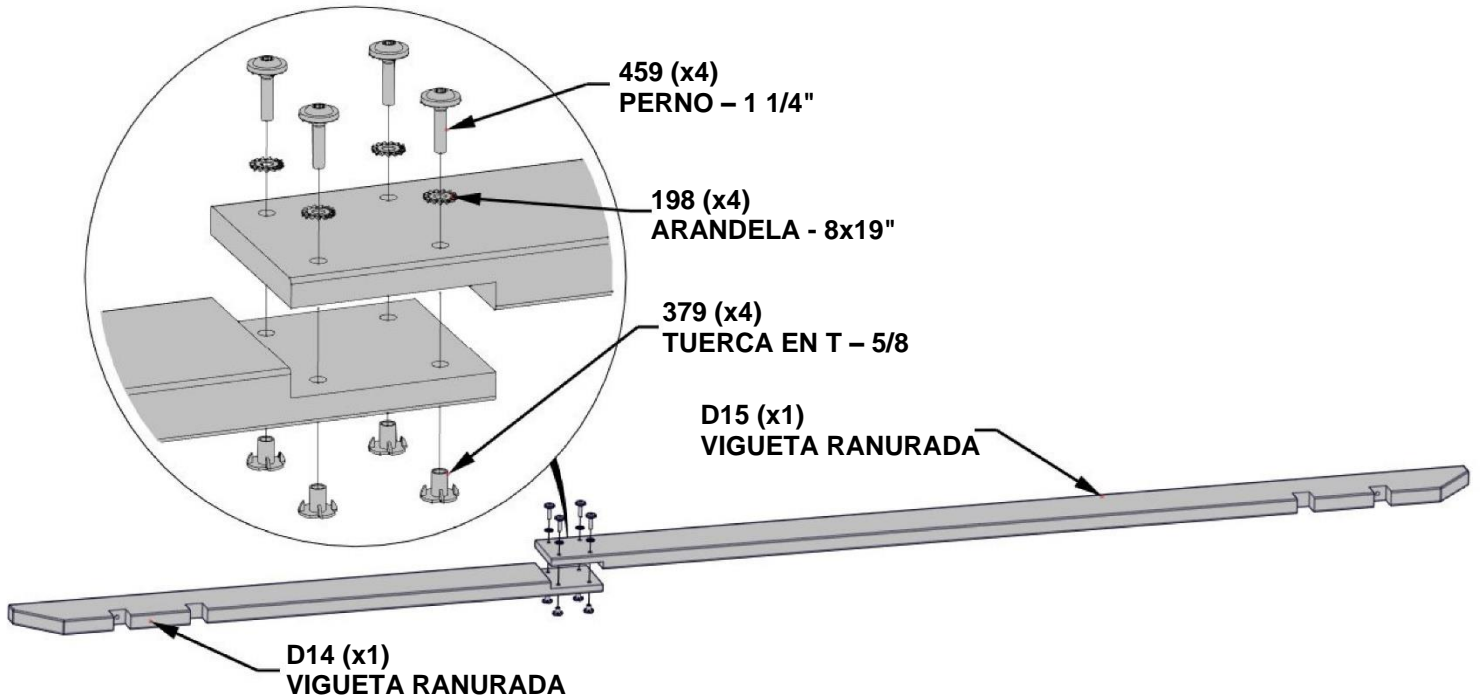

PASO 13 - MONTAJE DE LA PÉRGOLA

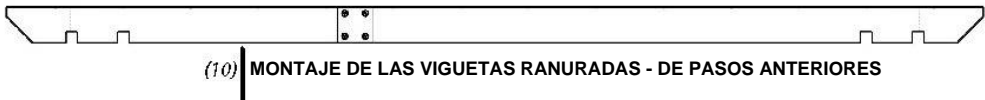

H100204 | TIRAFONDO BL NG
(20) 5/16x5 1/2



H100198 | ARANDELA DE FIJACIÓN
(20) EXT NG 8x19

FIJE EL MONTAJE DE LA VIGUETA RANURADA USANDO LOS ORIFICIOS GUÍA QUE ESTÁN EN EL MONTAJE DE LA VIGUETA EXTERIOR

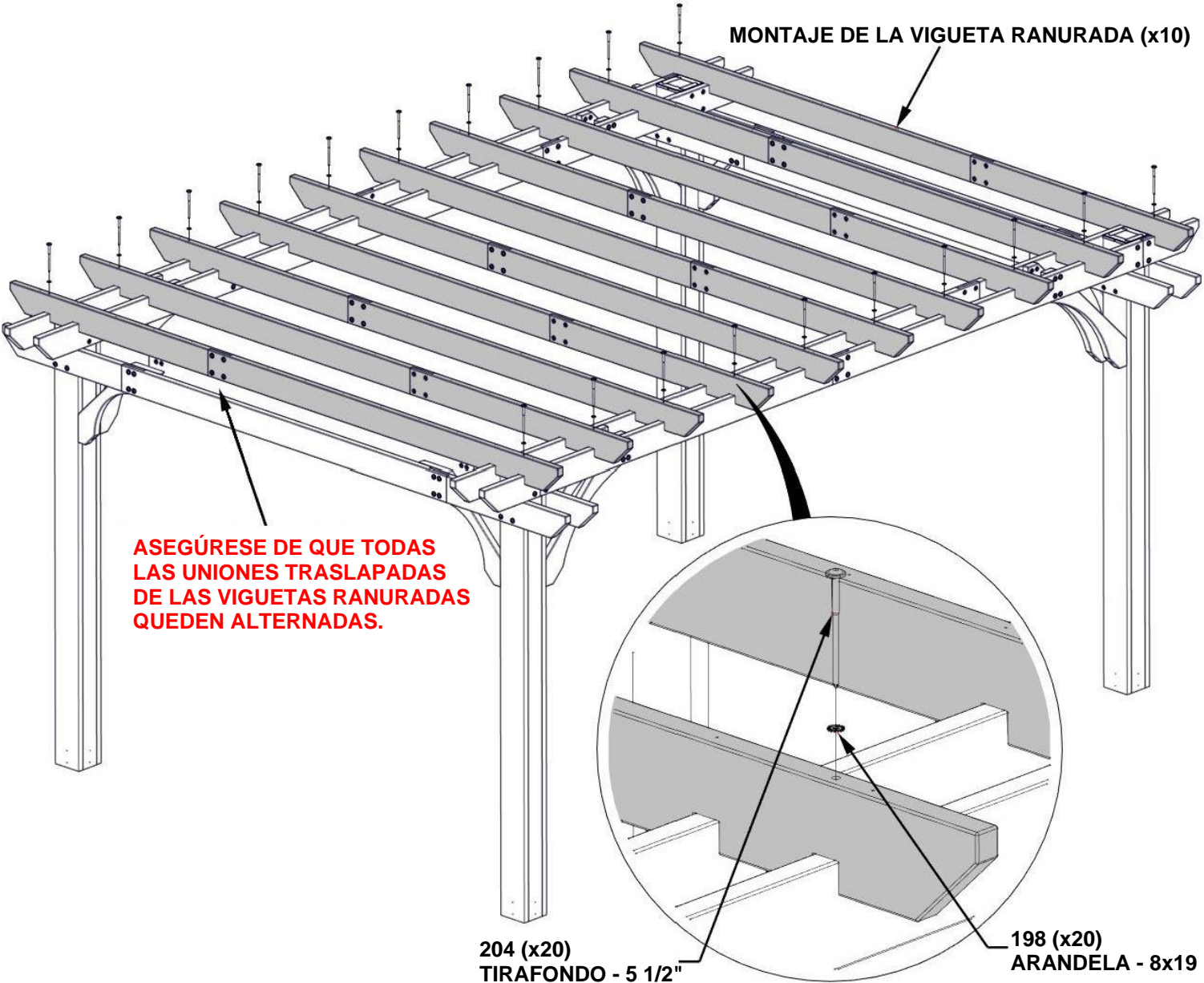

PASO 14 - MONTAJE DE LA PÉRGOLA



P10 EXTREMO DE LA CORREA - W4L15521
(28) 1 3/8"x1 3/8"x68 3/4" (36x36x1746)



P11 EXTREMO DE LA CORREA - W4L15522
(14) 1 3/8"x1 3/8"x89 1/2" (36x36x2274)

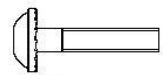

H100397 PERNO BL NG
(28) 1/4x1-1/4



H100405 ARANDELA DE FIJACIÓN
(28) EXT BLK 6x15



H100398 TUERCA EN T
(28) 1/4x7/16

COMPLETE ESTE PASO CATORCE VECES.

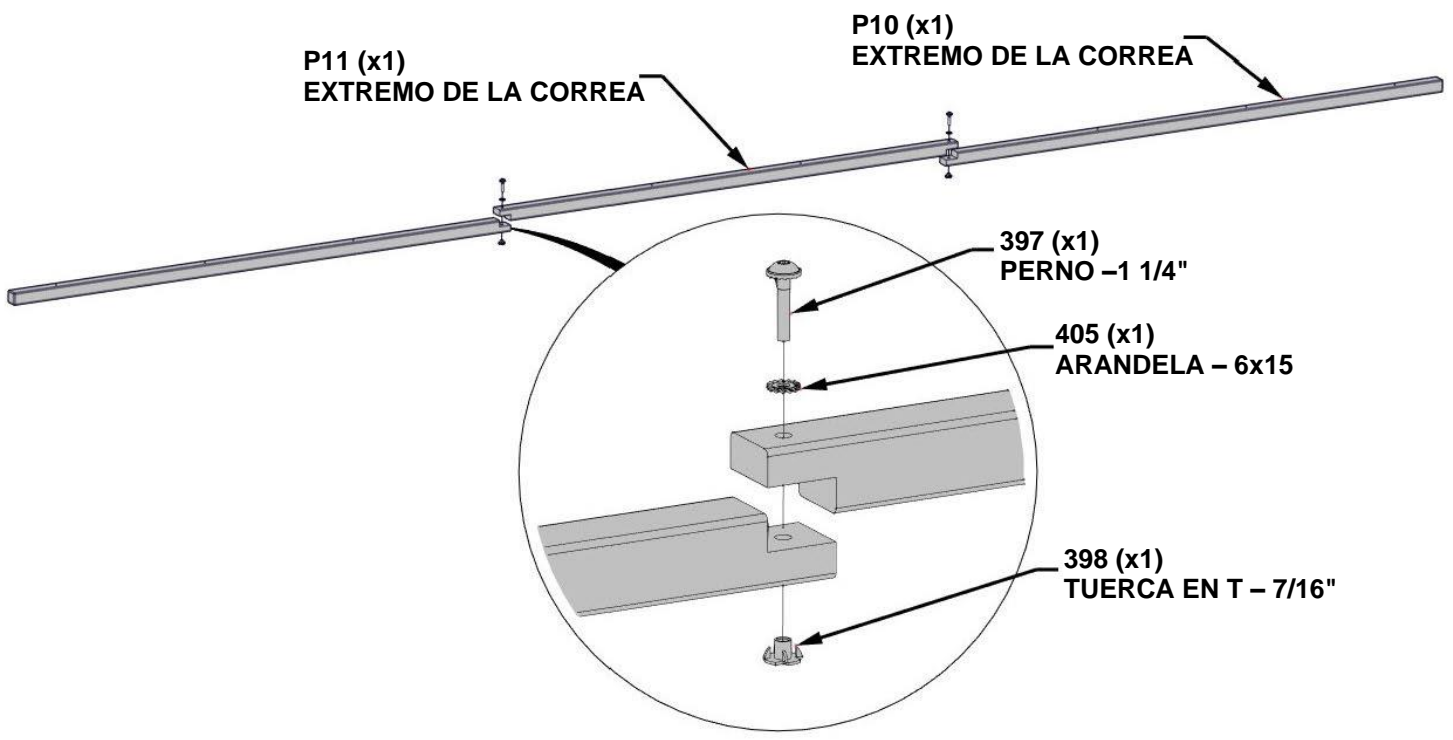

PASO 15 - MONTAJE DE LA PÉRGOLA

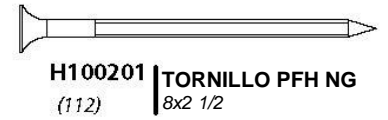

AL LEVANTAR CADA MONTAJE DE CORREA, ASEGÚRESE DE QUE LAS UNIONES ESTÉN APOYADAS Y DE QUE LA CORREA SE MANTENGA NIVELADA.

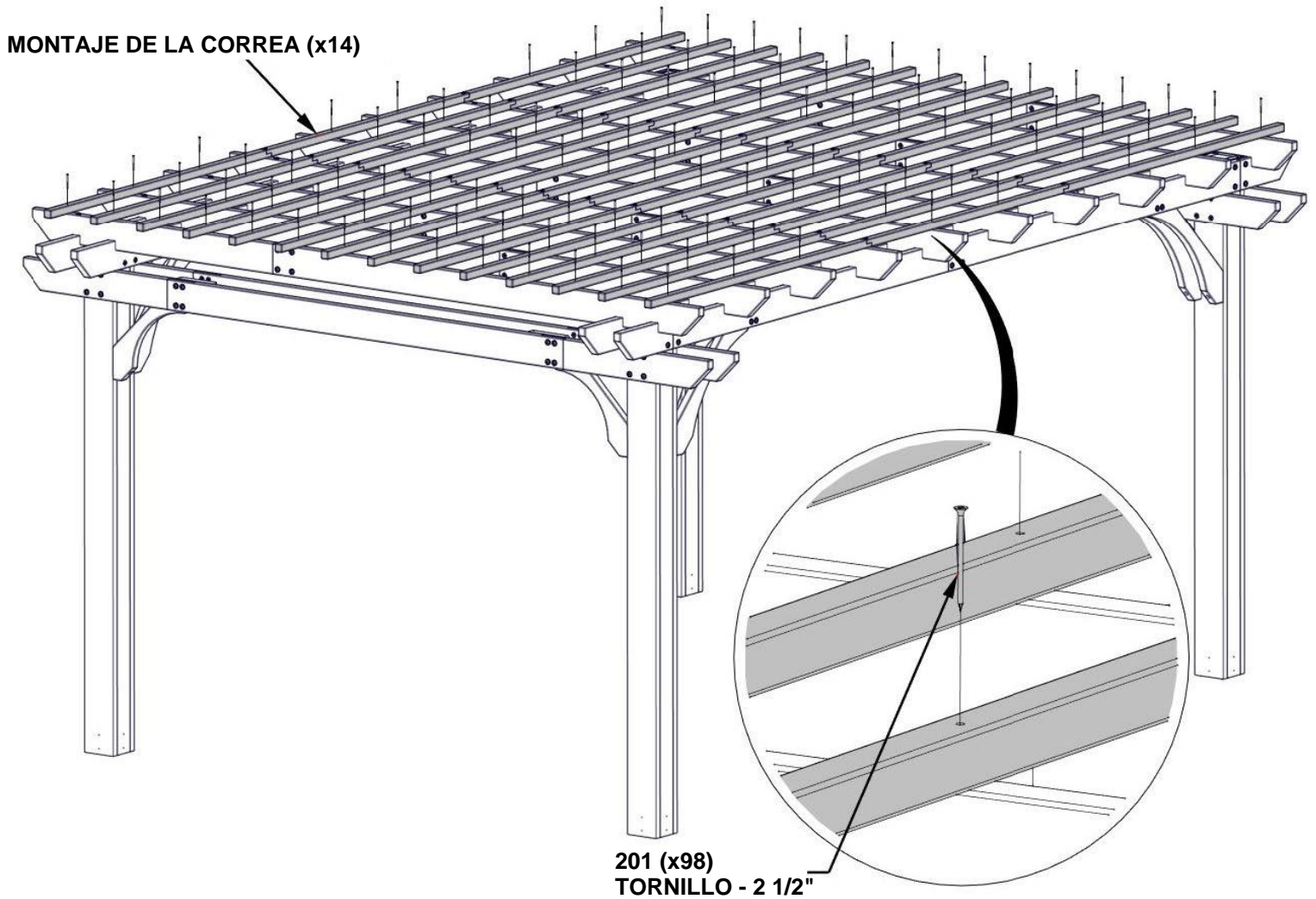

FIJE EL MONTAJE DE CORREA USANDO LOS ORIFICIOS GUÍA QUE ESTÁN EN EL MONTAJE DE LA VIGUETA RANURADA.

PASO 16 - MONTAJE DE LA PÉRGOLA

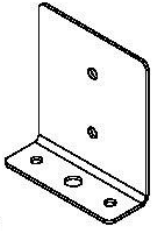

A4M00977 | PLACA DE ANCLAJE DE POSTE
(8)

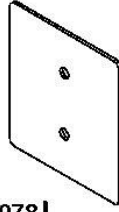

A4M00978 | PLACA DE POSTE
(8)

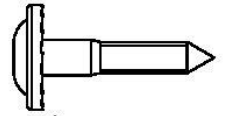

H100471 | TIRAFONDO BL NG
(32) | 5/16x1 1/2

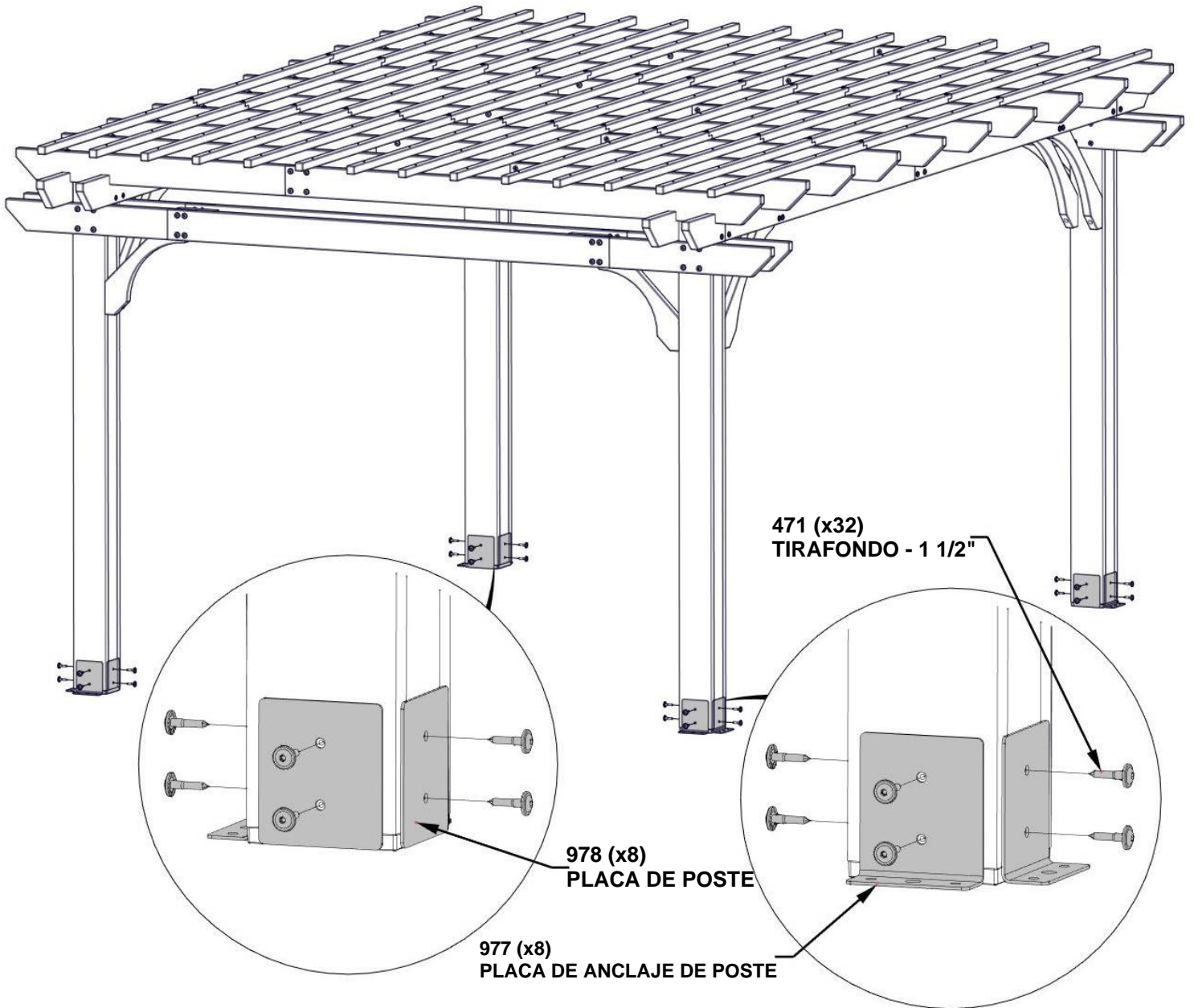

PASO 17 - MONTAJE DE LA PÉRGOLA



A100241
(1) | ETIQUETA DE IDENTIFICACIÓN
DE BACKYARD
(PEQUEÑA) SIN EDADES

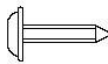

H100202
(2) | TORNILLO PWH NG
8x5/8

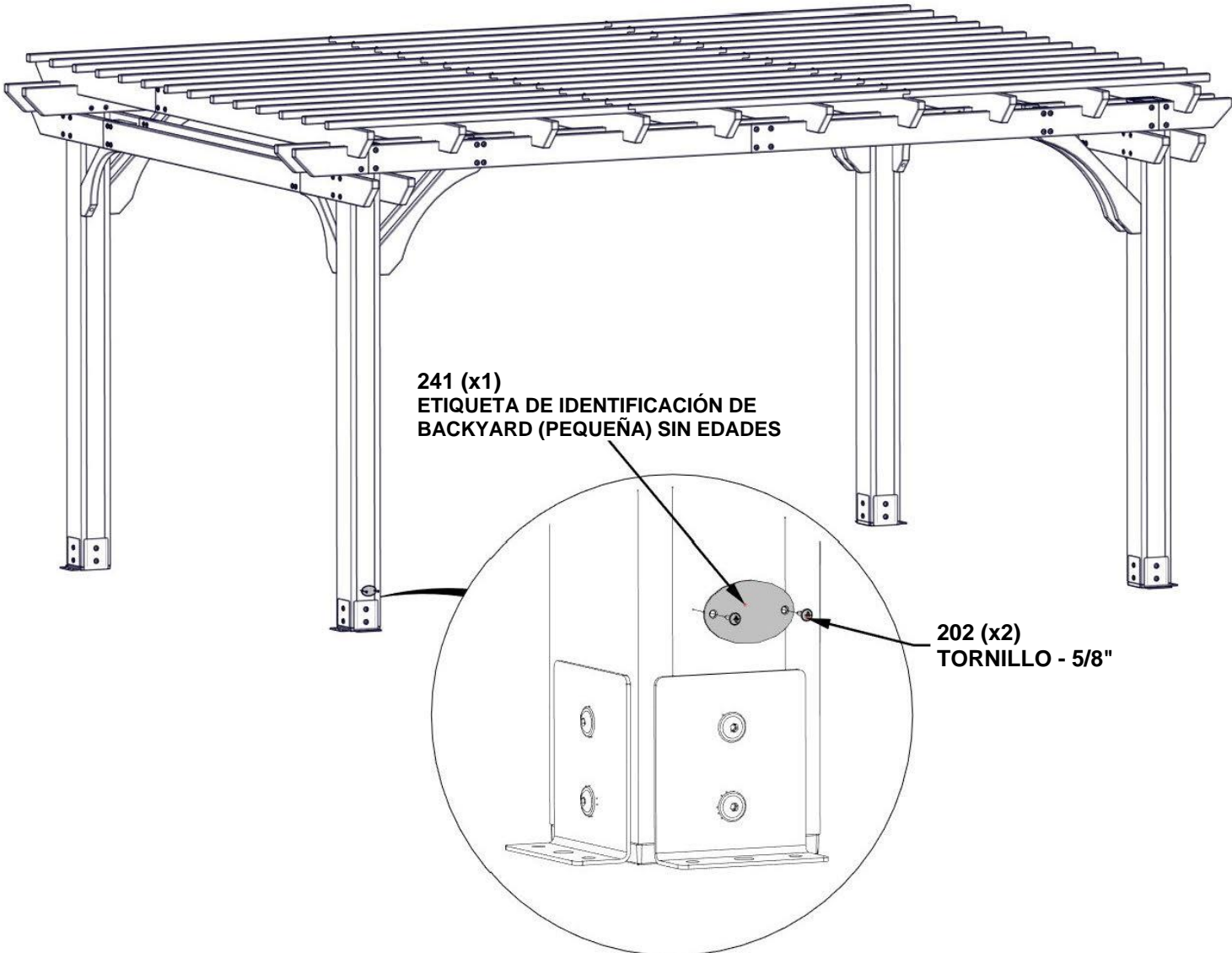

PASO 18 - MONTAJE DE LA PÉRGOLA



EL FABRICANTE RECOMIENDA LA INSTALACIÓN SOBRE UNA SUPERFICIE O UNA LOSA DE HORMIGÓN COMO SE MUESTRA A CONTINUACIÓN.

PARA INSTALAR SOBRE PLATAFORMAS DE MADERA, DEBE ASEGURARSE DE QUE EXISTA UN SOPORTE ESTRUCTURAL AMPLIO DEBAJO DE LA PLATAFORMA. NO SE INCLUYEN PIEZAS METÁLICAS PARA LA INSTALACIÓN DE LA CUBIERTA.

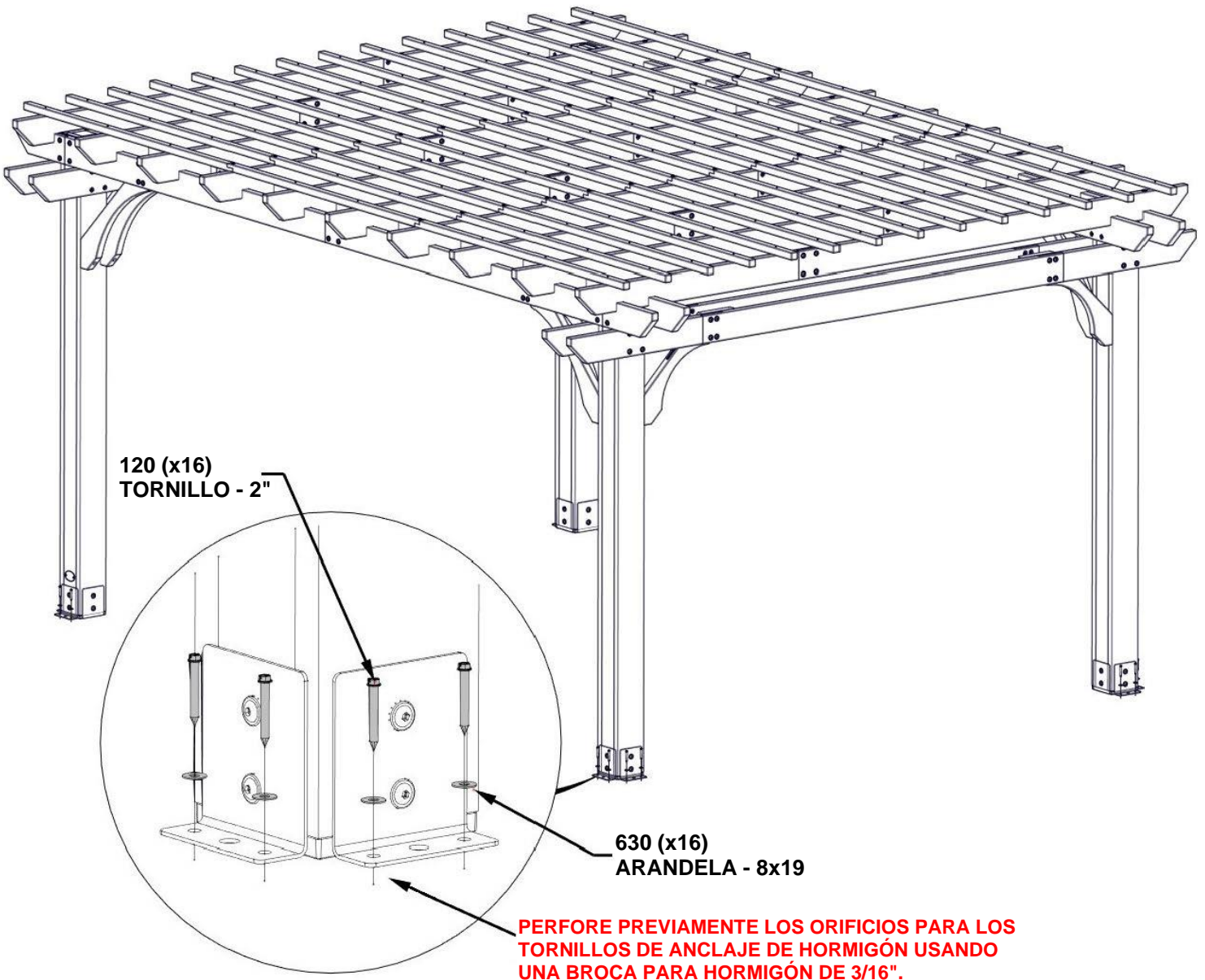

GABINETE ELÉCTRICO

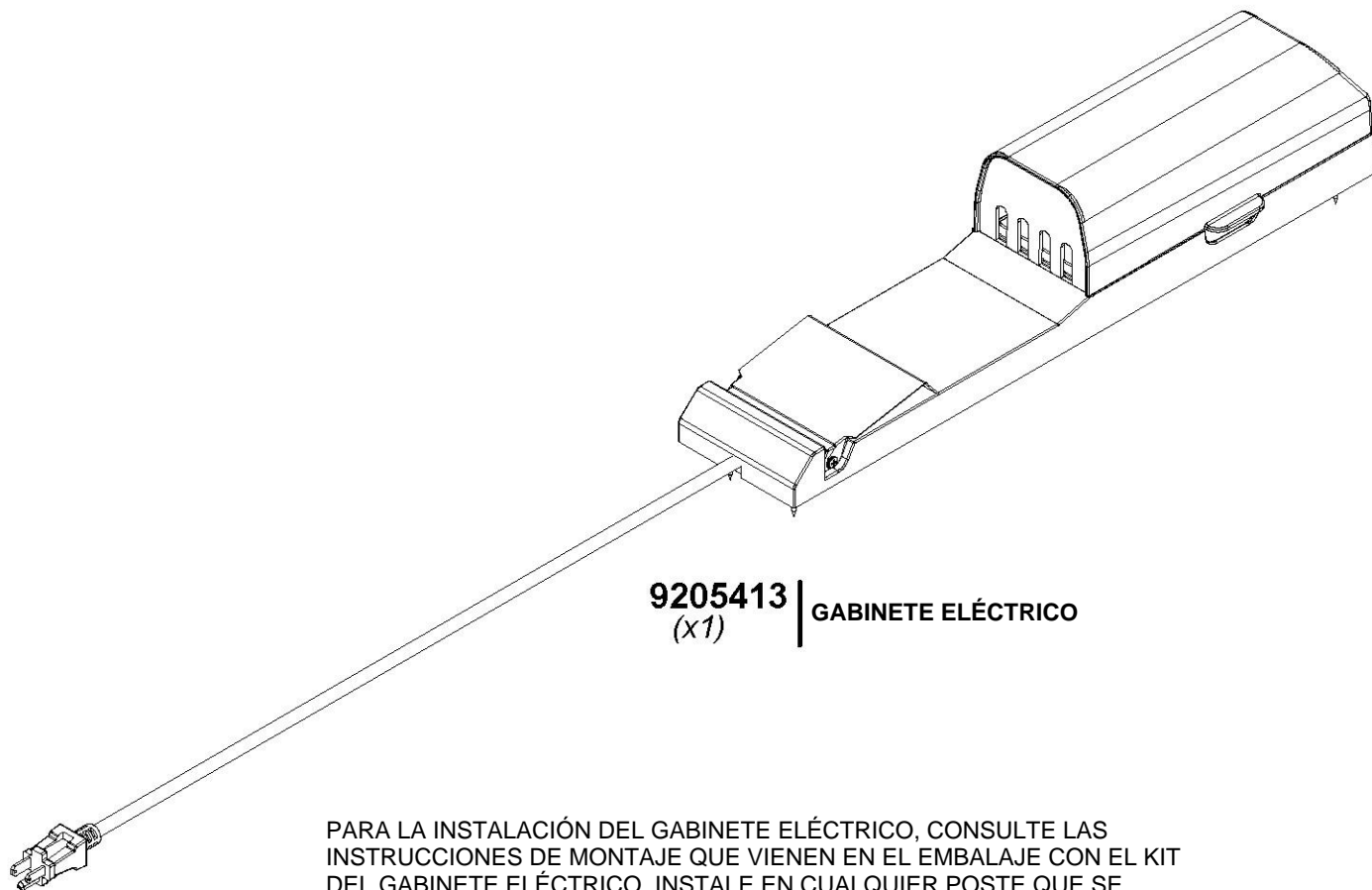

9205413 | GABINETE ELÉCTRICO
(x1)

PARA LA INSTALACIÓN DEL GABINETE ELÉCTRICO, CONSULTE LAS INSTRUCCIONES DE MONTAJE QUE VIENEN EN EL EMBALAJE CON EL KIT DEL GABINETE ELÉCTRICO. INSTALE EN CUALQUIER POSTE QUE SE DESEE. SIGA LAS INSTRUCCIONES PARA UNA INSTALACIÓN CORRECTA.